



# Automated Hydraulic Pressure Calibrator



# Additel 762 Automated Hydraulic Pressure Calibrator

## ----- User Manual

Please download the latest version from [www.additel.com](http://www.additel.com)

[Version:2409V04]

**Additel Corporation**



## **STATEMENT**

This user manual provides operating and safety instructions for the ADT762 Automated Hydraulic Pressure Calibrator. To ensure correct operation and safety, please follow the instructions in this manual. Additel Corporation reserves the right to change the contents and other information contained in this manual without notice



---

# Content

<b>Safety instructions .....</b>	<b>1</b>
<b>Cautious.....</b>	<b>3</b>
<b>1. Introduction .....</b>	<b>4</b>
1.1 Overview .....	4
1.2 Features.....	4
1.3 Pressure Specifications.....	6
1.4 Other Specifications .....	8
<b>2. Installation .....</b>	<b>12</b>
2.1 Features .....	12
2.1.1 Basic structure .....	12
2.1.2 Electrical and signal port.....	15
2.1.3 Keypad.....	16
2.1.4 Liquid port .....	17
2.2 Initial preparation.....	17
2.2.1 Battery installation.....	17
2.2.2 Connect to DUT .....	19

2.2.3 Open the display .....	20
2.3 Getting started.....	20
2.3.1 Power on.....	20
2.3.2 Setting the system date and time.....	20
2.3.3 Generating a pressure .....	20
2.3.4 Display and operation .....	21
2.3.5 Powering off the unit .....	21
<b>3. Display and Operation .....</b>	<b>22</b>
3.1 Home screen.....	22
3.1.1 Status bar.....	23
3.1.2 Module function display area .....	25
3.1.3 Main interface keypad operation .....	25
3.2 Pressure control.....	26
3.2.1 Pressure output.....	26
3.2.2 Pressure measurement.....	30
3.2.3 Pressure unit.....	31
3.3 Electrical signal measurement .....	31
3.3.1 Current/Voltage measurement .....	31

---

3.3.2 Switch test.....	35
3.3.3 HART Communication .....	36
3.3.4 PROFIBUS PA communication .....	45
3.4 Electrical output.....	46
3.5 External pressure module .....	50
3.6 Typical applications on main page .....	52
3.6.1 Pressure gauge calibration .....	52
3.6.2 Pressure transmitter Calibration.....	54
3.6.3 HART transmitter calibration .....	56
3.6.4 Pressure switch calibration .....	57
3.6.5 I/P converter.....	58
<b>4. Setup .....</b>	<b>61</b>
4.1 Control settings .....	61
4.2 Communication .....	63
4.2.1 Ethernet .....	63
4.2.2 Wireless communication .....	64
4.2.3 Bluetooth.....	65
4.2.4 USB port .....	66

4.3 Power management.....	66
4.3.1 Display brightness.....	66
4.3.2 Battery information.....	66
4.3.3 Energy settings.....	67
4.4 System calibration.....	68
4.4.1 Calibration of electrical measurement.....	69
4.4.2 Auto tune.....	70
4.4.3 Calibration of the pressure source module.....	70
4.4.4 Calibration of the pressure module.....	71
4.4.5 Calibration Expiration Reminder.....	72
4.5 Services.....	73
4.5.1 Firmware upgrade.....	73
4.5.2 Maintenance.....	73
4.5.3 Factory reset.....	74
4.5.4 Pressure release.....	75
4.5.5 Liquid Exhaust.....	75
4.5.6 Liquid change.....	76
4.5.7 Piston maintenance.....	77

---

4.5.8 Accumulator replacement.....	78
4.6 Personalization.....	80
4.6.1 Date and time.....	80
4.6.2 Language.....	81
4.6.3 Sound.....	81
4.6.4 CSV file.....	82
4.7 Cloud service.....	82
4.8 Data management.....	82
4.9 Product information.....	83
4.9.1 Host information.....	83
4.9.2 Control board information.....	83
4.9.3 Electrical measurement board information.....	83
4.9.4 Electrical source board information.....	84
4.9.5 Wireless module information.....	84
4.9.6 PROFIBUS module information.....	84
4.9.7 HART communicator information.....	84
<b>5. Documenting Tests.....</b>	<b>85</b>
5.1 Quick test.....	85

5.1.1 Pressure gauge.....	85
5.1.2 Pressure transmitter.....	86
5.1.3 Pressure switch.....	87
5.1.4 Pressure sensor.....	88
5.1.5 I/P converter.....	88
5.1.6 Signal isolator .....	89
5.2 Task.....	89
5.2.1 Dial pressure gauge.....	90
5.2.2 Digital pressure gauge .....	94
5.2.3 Pressure transmitter.....	94
5.2.4 Pressure Transducer.....	97
5.2.5 Pressure switch.....	99
5.2.6 I/P converter.....	101
5.2.7 Signal isolator .....	103
5.2.8 Electric Contacting pressure gauge .....	106
5.2.9 Valve opening gauge.....	109
<b>6. Application.....</b>	<b>112</b>
6.1 Unit conversion .....	112

---

6.2 Pressure leak test .....	112
6.3 Data log.....	115
<b>7. HART Communicator.....</b>	<b>118</b>
7.1 HART connection and search .....	118
7.2 HART communicator operation .....	118
<b>8. System maintenance.....</b>	<b>120</b>
8.1 Device information view .....	120
8.2 Diagnostic information.....	120
8.3 Check the sealing performance of the calibrator .....	120
8.4 Maintenance .....	121
8.4.1 Liquid reservoir .....	121
8.4.2 Liquid reservoir filling .....	123
8.5 Replace the output filter and O-ring .....	124
8.6 Special notice for water version .....	125

## Figure content

Figure 1 Basic structure .....	12
Figure 2 Electrical and signal port .....	15
Figure 3 Battery installation.....	18
Figure 4 Connect to DUT .....	19
Figure 5 Filling diagram.....	21
Figure 6 Home screen.....	22
Figure 7 Remove the single port .....	26
Figure 8 External pressure control connection (with ADT107 manifold).....	27
Figure 9 Current measurement .....	32
Figure 10 Voltage measurement .....	33
Figure 11 Mechanical Switch.....	35
Figure 12 NPN Switch.....	36
Figure 13 PNP Switch .....	36
Figure 14 HART internal power / resistance.....	38
Figure 15 HART external power / resistance.....	38
Figure 16 HART internal power / external resistance .....	38
Figure 18 Current output of internal power supply .....	47

---

Figure 19 Connection of the external module .....	51
Figure 20 Connect a dial pressure gauge .....	53
Figure 21 Connect a digital pressure gauge .....	53
Figure 22 Calibration of a 2-wire pressure transmitter .....	55
Figure 23 Calibration of a 3-wire pressure transmitter .....	56
Figure 24 Calibration of a 4-wire pressure transmitter .....	56
Figure 25 Calibration of a pressure switch .....	58
Figure 26 Calibration of an I/P converter .....	59
Figure 27 Auto tune connection .....	70
Figure 29 disassembling the accumulator .....	79
Figure 30 Install the accumulator .....	79
Figure 31 Calibration of the pressure transducer .....	97
Figure 32 Calibration of the signal isolator .....	104
Figure 33 Calibration of the electric contacting pressure gauge .....	106
Figure 34 Calibration of the valve opening gauge .....	109
Figure 35 Disassembly of the liquid reservoir .....	121
Figure 36 Reservoir Assembly Maintenance .....	122
Figure 37 Liquid reservoir filling .....	123
Figure 38 Maintenance of pressure outlet .....	124

## Table Content

Table 1 Selection guide .....	6
Table 2 Optional external CDP module .....	7
Table 3 Functional specifications .....	8
Table 4 Electrical measure specification .....	9
Table 5 General specifications .....	10
Table 6 Basic structure .....	13
Table 7 Electrical and signal port .....	15
Table 8 Keypad function.....	16
Table 9 Auto step settings .....	29
Table 10 Scaling parameters.....	33
Table 11 Filtering parameters .....	34
Table 12 Hart Parameters .....	40
Table 13 Auto-step parameters .....	48
Table 14 Ramp parameters .....	49
Table 15 Network connecting .....	63
Table 16 Static mode selection .....	64
Table 17 Wireless network selection .....	64

---

Table 18 Setup of wireless communication .....	65
Table 19 Bluetooth setup.....	65
Table 20 Serial set up.....	66
Table 21 Date and time .....	80
Table 22 Sound setup .....	81
Table 23 Setup of cloud service .....	82
Table 24 Task mode dial pressure gauge information .....	90
Table 25 Task setting of dial pressure gauge .....	91
Table 26 Task save.....	93
Table 27 Task mode pressure transmitter information.....	95
Table 28 Task mode pressure transducer information.....	98
Table 29 Task mode pressure switch information.....	99
Table 30 Task mode I/P converter information .....	102
Table 31 Task mode signal isolator information.....	104
Table 32 Task mode contact pressure gauge information .....	107
Table 33 Task Setting of contact pressure gauge.....	108
Table 34 Task mode valve opening gauge information.....	110
Table 35 Data logging module selection.....	116
Table 36 Data logging information settings .....	116



---

## Safety instructions

- ◆ Do not introduce another pressure source to the same UUT when the ADT762 unit is applying pressure to it at the same time. Any damage incurred will not be covered under warranty;
- ◆ Do not apply pressure beyond the range of the calibrator, and the accident caused by this will not be covered by the warranty;
- ◆ Not for use in flammable, high humidity, or dusty environments;
- ◆ Do not expose the battery of unit to fire;
- ◆ Charge the battery only using the Additel adapter. Please follow proper recycling procedures when discarding the battery.
- ◆ The estimated End of Life (EOL) expectancy for all hoses and filters (pneumatic and hydraulic) is approximately 10 years and should be replaced at the first sign of wear or damage. These hoses and filters can be sold separately as kits or included in the accessories for various products, such as pressure controllers and calibrators. Failure to replace these hoses and filters beyond their EOL may result in poor performance of the product or potential physical harm to the operator.

**To prevent user from injury, be sure to use this product in accordance with the user manual.**

**To prevent possible fire, electric shock or personal injury:**

1. General:

- ◆ Before using the device, please read the user manual first, especially the "Safety Instructions" section;
- ◆ The device must be operated by trained professionals to prevent operator injury or equipment damage;



- 
- ◆ Before using the device, please check its appearance for any damage;
  - ◆ Do not operate the device in any orientation other than the upright;
  - ◆ In case of the device is damaged or malfunctions, please do not use it and contact Additel;

2. Electrical:

- ◆ Due to the high voltage inside the device during use, please do not disassemble it without permission.

## **Cautious**

- ◆ Do not shake, drop or bump the calibrator while in use;
- ◆ If condensation has occurred, thoroughly dry out the 762 before startup;
- ◆ It is recommended to replace the medium (except for water medium) every 3 months. If the medium is contaminated, it needs to be replaced in time;
- ◆ Do not apply more than 30V between any two electrical jacks (except for voltage measurement jacks);
- ◆ Do not use any adapter other than Additel power adapter designed for the ADT762. Charge the battery as soon as the battery symbol indicates.
- ◆ If the calibrator is not working properly, turn it off, remove the battery and contact Additel.
- ◆ Do not remove the battery while it is charging or when the calibrator is in use.
- ◆ Before turning off the calibrator, make sure the system pressure is reduced to the atmosphere pressure.
- ◆ If the battery is not used for a long time, it should be charged to 50% to 80%, and it should be taken out of the device and stored in a dry and cool environment. Charge the battery every 3 months to prevent it from being too low due to self-discharge and cause irreversible loss of capacity or even damage;
- ◆ For water medium version, the medium should be drained before low temperature storage.



## **1. Introduction**

### **1.1 Overview**

The Additel 762 Automated Pressure Calibrator is unlike any other pressure calibrator on the market. This revolutionary product is a complete turnkey solution for automation of pressure calibration work up to 10,000 PSI.

Designed for use in both the field and the laboratory, the portability and accuracy of this state-of-the-art product will quickly become the favorite go-to calibrator for lab personnel and field technicians alike.

With fully automated support for calibration of pressure transmitters, switches, dial and digital gauges and sensors, including HART/PROFIBUS devices in conjunction with a fully integrated task feature, data collection and Wi-Fi connectivity, we had our customer's needs in mind when designing our most capable pressure calibrator to date.

### **1.2 Features**

#### **1. Intelligent Pressure Control**

- ◆ Pressure output range: 15~10,000 psi (1-700 Bar)
- ◆ Control Stability:  $\leq 0.005\%FS$
- ◆ Stability Duration:  $> 5$  min
- ◆ Dual range accuracy up to  $0.01\%FS$

#### **2. Built-in Auto-Purge Application**

Purging hydraulic calibration systems can be challenging and time consuming. The ADT762 has been designed with an

integrated auto-purge system that saves time, money and frustration by completely automating the removal of air from the system. With the push of a button, the ADT762 quickly manages the system purging. This helps to free up time for technicians to attend to other needs.

### **3. Documented Task Feature**

The powerful documented calibration task application allows users to quickly create and execute tasks without the need for a PC or tablet. The ADT762 automatically analyzes errors, generates test reports, while storing results locally. The Additel 762 can support up to 1000 documented tasks which can be stored and recalled at any time to help save time and money.

### **4. Easy Maintenance**

- ◆ Check the medium level through the view window
- ◆ Removable reservoir with filter
- ◆ Liquid change notification, auto liquid change function

### **5. Dual-Mode HART Communication**

HART pressure transmitters can be directly maintained and calibrated without any other equipment or tools. The ADT762 provides an automatic HART calibration mode as well as a manual mode. This dual-mode HART communication function not only provides an efficient and convenient interoperability mode for DUT, but also supports access to a fully HART capable calibrator.

### 1.3 Pressure Specifications

Table 1 Pressure Specifications

Model	ADT762 Automated Hydraulic Pressure Calibrator	
Specification		
Pressure Range	15~10,000 psi (1-700 Bar)	
Range Selection	Manual 3K psi, Manual 10K psi or Auto-range	
Accuracy	0~10,000 psi, <b>0.01%FS</b>	0~10,000 psi, <b>0.02%FS</b>
	0~3,000 psi, <b>0.01%FS</b>	0~3,000 psi, <b>0.02%FS</b>
Maximum External Load Capacity	Max: 80 ml@700 Bar, 50 ml recommend	
Reservoir	Max: 350 ml, built-in filter	
Control Stability <sup>[1]</sup>	0.005%FS from 100 to 10,000 psi	
Stability Duration	> 5 min	
Pressure Module	Built-in one module with dual range	
External Control Pressure Module	See the following "External Control Pressure Module Specification and Compatibility" table	
External Measurement Pressure Module	All ADT161 pressure modules	

[1] Control Stability is based on the range selection or external module.

Table 2 Optional external ADT161 module

Specification Model	Pressure Range		Accuracy	Pressure Type	Media	
	(psi)	(bar)				
ADT161-01-GPXX 0.01%FS	for	1,000	70	0.01% FS	Gauge	G,L
		1,500	100	0.01% FS	Gauge	G,L
		2,000	140	0.01% FS	Gauge	G,L
		3,000	200	0.01% FS	Gauge	G,L
		5,000	350	0.01% FS	Gauge	G,L
		10,000	700	0.01% FS	Gauge	G,L
ADT161-02-GPXX 0.02%FS	for	1,000	70	0.02% FS	Gauge	G,L
		1,500	100	0.02% FS	Gauge	G,L
		2,000	140	0.02% FS	Gauge	G,L
		3,000	200	0.02% FS	Gauge	G,L
		5,000	350	0.02% FS	Gauge	G,L
		10,000	700	0.02% FS	Gauge	G,L

## 1.4 Other Specifications

### 1. Functional Specification

Table 3 Functional Specification

Functional Specification	Details
Stability	$\leq 0.005\%FS$ , customizable
External module	See Table 2
Pressure type	Gauge pressure
Medium	Diethylhexyl sebacate, Deionized Water (762W)
Maximum external load volume	Max: 80 ml@700 Bar, 50 ml recommend
Liquid tank	Maximum liquid volume 350ml, Press-type through air vent, the user can quickly change the filter
Target pressure stabilization duration	> 5 mins
Response time	< 30 seconds@ 20%FS step @ 10ml external load volume
Output ports	M20x1.5 female quick connector

Note:

[1] Control stability is based on the range of the pressure control module;

[2] The control response time is when the load volume is not applied and 20% step of the range is completed.

2. Electrical specification (Environment temperature  $20^{\circ}\text{C} \pm 5^{\circ}\text{C}$ , 1 year accuracy)

Table 4 Electrical specification

Model Specification	Range	Resolution	Accuracy	Note
mA Measure	-25 to 25 mA	0.1 $\mu\text{A}$	$\pm (0.008\%RD + 1.0 \mu\text{A})$	Impedance <10 $\Omega$
	-50 to 50 mA	0.1 $\mu\text{A}$	$\pm (0.008\%RD + 2.0 \mu\text{A})$	
V Measure	-300 to 300 mV	1 $\mu\text{V}$	$\pm (0.008\%RD + 6 \mu\text{V})$	Impedance <1 G $\Omega$
V Measure (Auto-ranging)	-5 to 5 V	20 $\mu\text{V}$	$\pm (0.008\%RD + 100 \mu\text{V})$	Impedance >1 M $\Omega$
	-12 to 12 V	100 $\mu\text{V}$	$\pm (0.008\%RD + 320 \mu\text{V})$	
	-30 to 30 V	100 $\mu\text{V}$	$\pm (0.008\%RD + 600 \mu\text{V})$	
Loop Power Source	24 V	N/A	$\pm 1 \text{ V}$	50 mA (Max Loading)
mA Source	0 to 2.5 mA or	0-2.5 mA:	0-2.5 mA: $0.008\%RD+0.2$	20 mA @ 1 K $\Omega$
Power Source	16 to 30 V	1 V	$\pm 1 \text{ V}$	70 mA (Max Loading)
V Source	0 to 16 V	0.25 mV	$0.008\%RD+500\mu\text{V}$	
Pressure Switch	Mechanical Switch,	N/A	N/A	Response time<10
Temperature	18 $^{\circ}\text{C}$ to 28 $^{\circ}\text{C}$			
Temperature Coefficient	Outside of 18 $^{\circ}\text{C}$ to 28 $^{\circ}\text{C}$ : $<\pm (0.0005\%RD + 0.00005\%FS)/^{\circ}\text{C}$			
Misuse Protection	Up to 30 V on any two sockets			



Pressure Switch Test	●
HART / PROFIBUS PA	●

### 3. General specification

Table 5 General specification

Specification	Description
User Interface	Color touch screen and keypad operation
Display	7" TFT touch screen 800 x 480 color
Enclosure IP Rating	IP31
Power	Dedicated lithium battery or power adapter
Battery	Rechargeable Li-Ion battery, typically 12 hours of operation, less than 5 hours recharge.
Weight	28 lbs. (12.8 kg) without media
Medium	Diethylhexyl sebacate, Deionized Water (762W)
Size	11.81 x 8.66 x 7.56 in (300 x 220 x 192 mm)
Communications	USB, LAN, Bluetooth, Wi-Fi and Ethernet
HART Communication	Read, configure and calibrate HART devices - DD files updated periodically
Data Storage	> 8 GB
Data Logging	Up to 1,000,000 readings (data and time stamped)

Task Documentation	Up to 1,000 tasks can be stored with data
Automation Functions	Switch test, auto step, leak test
User Interface Localization	English, German, French, Italian, Spanish, Portuguese, Chinese, Japanese, and Russian
Pump Life	> 1,000,000 cycles
Environmental Specifications	Operating temperature: 32 °F to 122 °F ( 0 °C to 50 °C)
	Storage temperature: -20 °C to 60 °C ( -4 °F to 120 °F)
	Humidity: <90%, non-condensing
Certification	ISO 17025 accredited certificate of calibration with NIST-traceable data
Compliance	CE
Software Compatibility	ACal, Additel Land and Additel Link for access via mobile application
Warranty	18 months

## 2. Installation

### 2.1 Features

#### 2.1.1 Basic structure

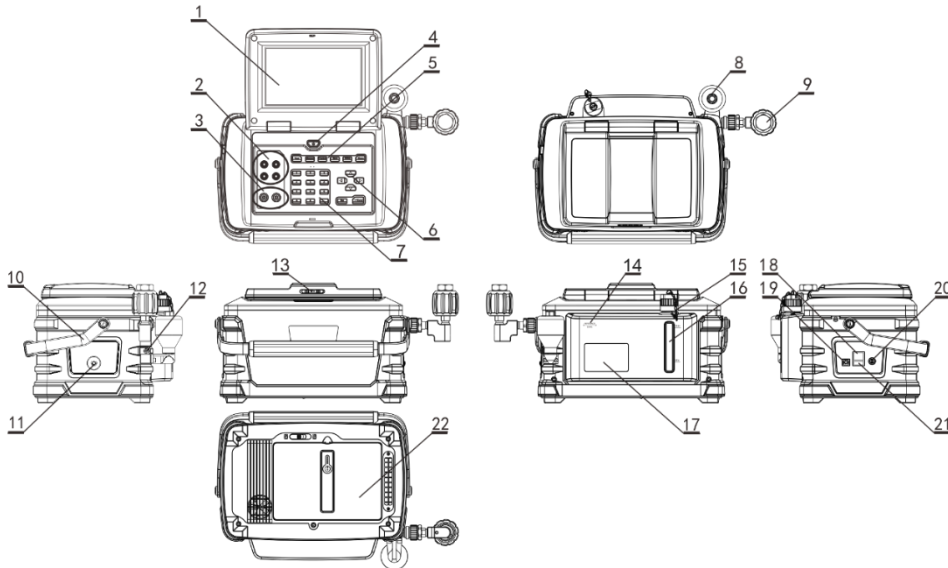

Figure 1 Basic structure

Table 6 Basic structure

Item	Name
1	Screen
2	Electrical testing ports
3	Pressure module ports
4	On/Off
5	Shortcut keys
6	Navigation keys
7	Numeric Keypad
8	Accumulator
9	Output port
10	Hanging strap
11	Block
12	Zeroing return manifold communication port
13	Display assembly clamp
14	Head correction reference line
15	Medium Refill / Reservoir vent port



---

16	Medium viewing window
17	Label
18	LAN Interface
19	USB slave port
20	Power supply
21	USB master port
22	Battery

## 2.1.2 Electrical and signal port

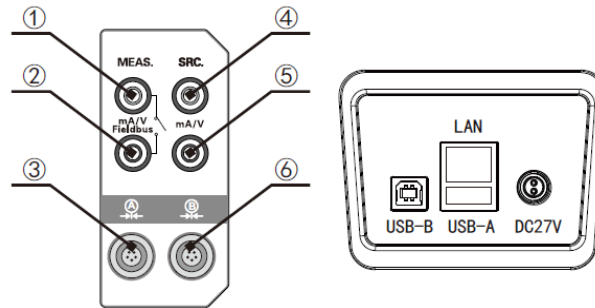

Figure 2 Electrical and signal port





Table 7 Electrical and signal port







Port	Description
①②	Current, Voltage, Switch measurement and HART, Profibus PA bus communication, Red is positive , Black is negative
④⑤	Current, Voltage and power output, Red is positive , Black is negative

③	Jack A for connecting external pressure module
⑥	Jack B for connecting external pressure module
DC27V	Power adapter connection port
LAN	Ethernet port
USB-A	USB master, for flash drive connection
USB-B	USB slave, for computer connection

### 2.1.3 Keypad

Table 8 Keypad function

Item	Keypad	Description
1		On/Off Key: Power
2		Shortcut Key: Pressure vent
3		Shortcut Key: Pressure measurement mode
4		Shortcut Key: Pressure Controlling mode
5		Shortcut Key: Snapshot

6		Shortcut Key: Setup interface
7		Shortcut Key: Return home
8		Shortcut Key: Cancellation or Return function
9		Shortcut Key: Fulfillment or confirmation function
10		Navigate key: Up, down, left, right key
11		Numeric Key

### 2.1.4 Liquid port

OUTLET: The pressure output interface is connected to the equipment to be calibrated. The volume of the calibration equipment should not be too large. At the same time, pay attention to check the liquid level of the liquid storage tank.

## 2.2 Initial preparation

### 2.2.1 Battery installation

As shown in Figure 3, install the battery: after taking out the battery, insert the battery in the direction shown in step ①,

so that the battery lock is in a locked state, as shown in ② in the figure; remove the battery: reverse the operation and push the battery manually lock, make the battery lock unlocked, and remove the battery, as shown in Figure ③, be careful that the battery falls during this process.

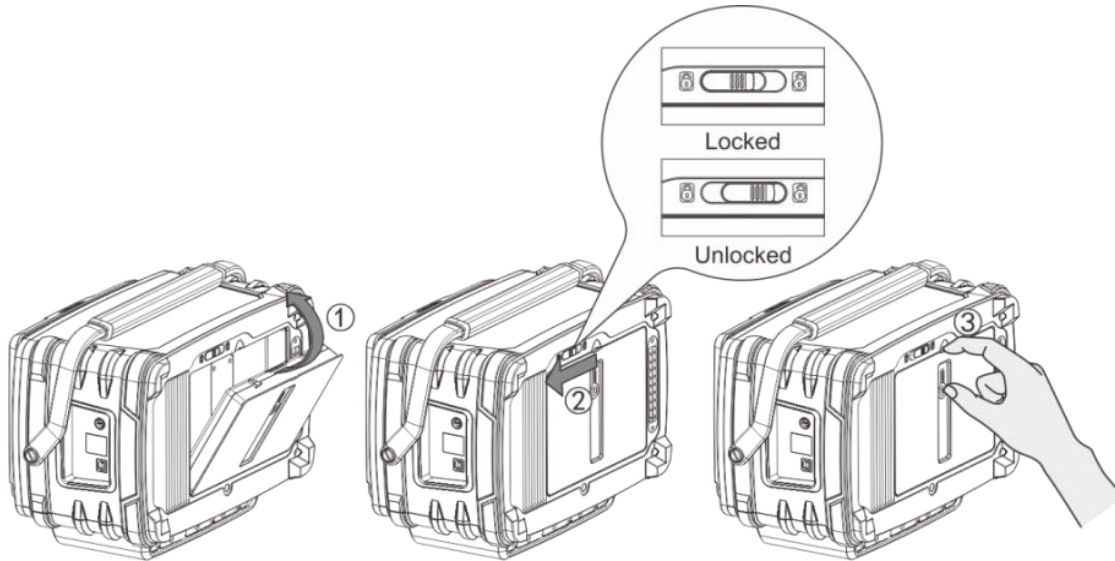

Figure 3 Battery installation

### 2.2.2 Connect to DUT

As shown in Figure 4.

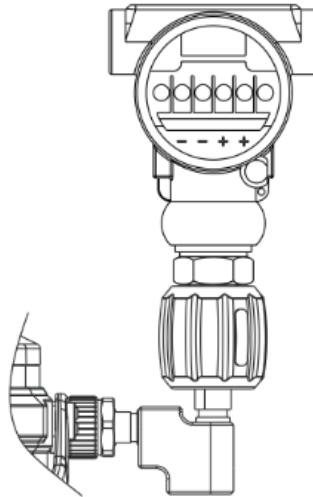



Figure 4 Connect to DUT

### 2.2.3 Open the display

Push the lock on the cover to the right to open the screen to a suitable angle.

## 2.3 Getting started

### 2.3.1 Power on

- ◆ Press  to turn the power on.
- ◆ The startup screen shows the manufacturer's logo.
- ◆ After a short time the system enables the home screen.
- ◆ Connect the power supply for charging if power is low.
- ◆ If calibrator is charging, the screen go into the charging display, press  to turn it on.

### 2.3.2 Setting the system date and time

- ◆ Refer to section 4.6.1 to set date and time

### 2.3.3 Generating a pressure

1. Fill the medium: firstly rotate the cover of the liquid storage tank to remove it and fill in the required working medium, as shown in state I (Filling) in Figure 5, the medium height needs to be between the Min mark line and the Max mark line;

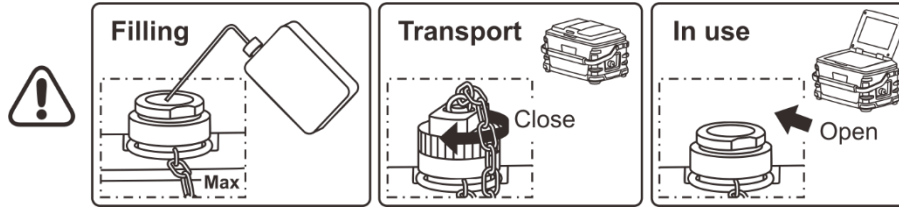



Figure 5 Filling diagram

2. Reinstall the cover and press the button to make it in state III ( In use ) ;
3. If the output port is not connected to a pressure UUT device, the output port needs to be effectively blocked.
4. In the main operation interface, set a pressure within the range as the target value, and the calibrator will control and output the pressure to the target value pressure.

### 2.3.4 Display and operation

Touchscreen display makes operation easier, supports keypad operation, it is convenient to operate and input values quickly.

### 2.3.5 Powering off the unit

1. When the battery is installed on ADT762 but no power adaptor connected, long press power key  for more than 10 s to switch off the unit.
2. When the power adaptor is connected, please disconnect the adaptor at first. If the battery is installed, refer above steps.

### 3. Display and Operation

#### 3.1 Home screen

The home screen contains top status bar and modules functional areas, see figure 6.

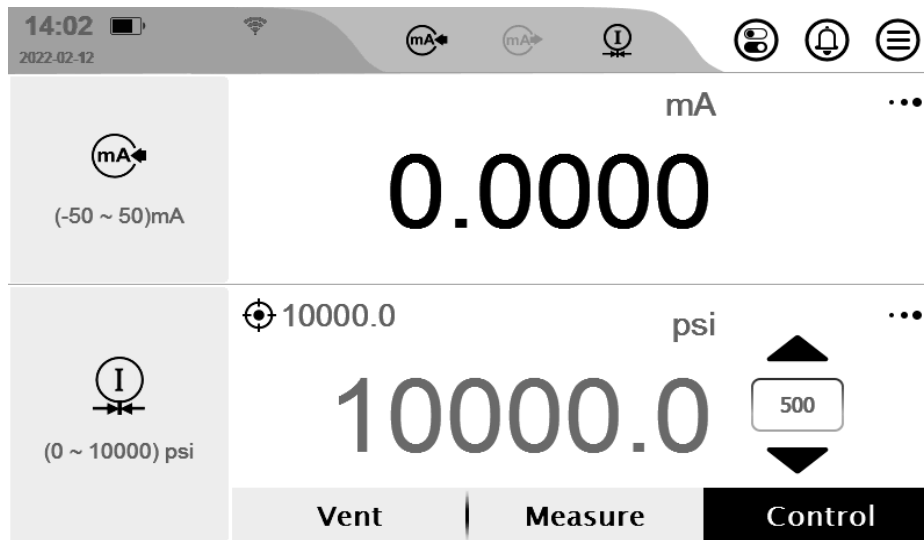









Figure 6 Home screen



### 3.1.1 Status bar







The status bar contains 3 parts: Status information, Module display/hidden operation and Function navigation.

#### 1. Status information display area



- ◆ Date and time
- ◆ Wi-Fi: Icon  indicates Wi-Fi connection status and signal intensity.
- ◆ LAN: Icon  indicates network activity.
- ◆ USB: Icon  indicates USB device activity
- ◆ Bluetooth: Icon  indicates Bluetooth function is working.
- ◆ Cloud service: Icon  indicates cloud service is working, icon  indicates cloud service is enabled, but has lost connection.
- ◆ Snapshot: Icon  indicates snapshot function is operating.

#### 2. Module function display/hidden operation area

- ◆ Modules can be displayed or hidden by clicking the corresponding function icon. When the module is in the display state, the icon is highlighted, when the module is in the hidden state, the icon is dim.
- ◆ Electrical measurement module display/hidden: Different icons will be displayed according to different electrical measurement features. When the  icon shows, it indicates the mA measurement is working. Click  icon, the measurement features part will be hidden and the icon will become dim.

- ◆ Electrical output module display/hidden: Different icons will be displayed according to different electrical output features. When the  icon shows, it indicates the mA output is working. Click  icon, the output features part will be hidden, but the arrow on the icon will be flickering to indicate it's still working.
- ◆ Pressure output module display/hidden: Icon ,  or  will be displayed according to the selected pressure control range
- ◆ External pressure module A display/hidden: Icon  will be displayed when pressure module A is connected
- ◆ External pressure module B display/hidden: Icon  will be displayed when pressure module B is connected.

### 3. Navigation function area















- ◆ Control center: Click icon  to enter the control center. The control center has many functions, including internal pressure module, electrical measurement signal, electrical output signal, external module A, external module B, battery level, piston position, pressure source Pin, piston pressure Pct, lock screen function, Bluetooth communication and Wi-Fi communication, etc.
- ◆ Notification center: If abnormal happen, the icon  will turn to red and highlight. Click the icon to view dynamic information about the abnormal information.
- ◆ Main menu: Click icon , the main menu including system configuration, HART communicator, quick test, task and application functions.

### 3.1.2 Module function display area

The module function display area is divided into electrical measurement area, electrical output area, external pressure module A and B (only when pressure modules are connected). Clicking "Module function display/hide operation area" in the status bar to show and hide the above functions, at the same time, module function display can be set from one to five screens.

- ◆ Pressure output area: see section 3.2 pressure control.
- ◆ Electrical signal measuring area: see section 3.3 electrical measurement.
- ◆ Electrical signal output area: see section 3.4 electrical signal output.
- ◆ External pressure module A & B areas: see section 3.5

### 3.1.3 Main interface keypad operation

- ◆ When the display is under main interface, click  or  buttons, you can choose each function area icons, the selected function will have orange frame. Press  to trigger corresponding function, press  to quit.
- ◆ Press  ~  /  /  to type targeted value in pressure output area , then press  to start the pump and control to that pressure. Press  /  to adjust targeted value. If the pressure output is hidden and the electrical signal output area is displayed, press  and enter to electrical output area or press  /  to adjust electrical output value.

## 3.2 Pressure control

### 3.2.1 Pressure output

#### 1. Connection

(1) Output the pressure using internal module **I**, please refer to the Figure 4 to connect the UUTs.

(2) If wants to use external modules **A** or **B**, need a ADT107 manifold (Optional), and please follow the below steps to make the connection.

1) Remove the single port, as shown in Figure 7.

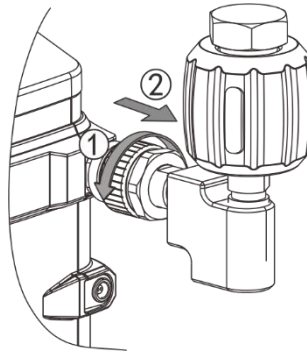

Figure 7 Remove the single port

Rotate the hexagonal nut counterclockwise (arrow 1) to unscrew it completely;

Take out the whole assembly (arrow ②).

2) Make connections with the ADT107 manifold and external modules, as shown in figure 8.

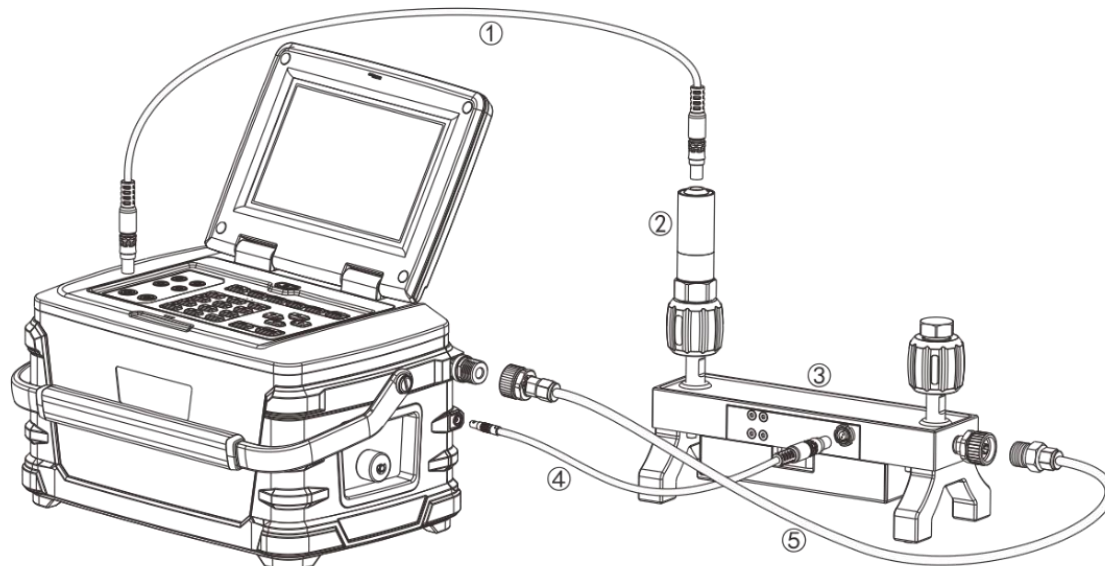





Figure 8 External pressure control connection (with ADT107 manifold)

Table 9 External pressure control connection

No.	Description
①	Cable for external pressure module
②	External pressure module
③	ADT107 Dual ports manifold with zero returning (Optional)
④	Zero return communication cable
⑤	ADT100-762Hose





## 2. Select the range

(1) In the status bar, press  ,  or  ; Open pressure control options: internal pressure range, external module A, external module B.

(2) Switch to the desired option as needed

Note: When the external control pressure is enabled, if an external pressure module is connected, there will be corresponding module A and B options.

## 3. Input target value

◆ Pressure output area, touch screen to enter value or press  ~  /  /  button on the main interface , then press  for confirmation.









- ◆ Press  /  to go to Step mode.
- ◆ The set value must meet the pressure control range of the calibrator. For the pressure control range, please refer to Para. 1. 6 Technical Specifications;
- ◆ When target pressure exceeds current pressure range of the internal module but within the range of the second internal module, it will switch to the applicable module.
  4. Start /stop controlling pressure
    - ◆ The Calibrator will start controlling after the target pressure value is achieved.
    - ◆ On the status of vent or measure, click  or “control” button on the screen to start controlling to the target pressure.
      - ◆ Press ,  or click “vent” and “measure” button on the screen to stop control.
  5. Pressure stabilize
    - ◆ When stable within the control settings(see Para. 4.1), the displayed pressure value will change to green.
  6. Auto step
    - ◆ Press **\*\*\*** to enter into auto step setting interface, see parameter in Table 10:

Table 10 Auto step settings

Subject	Valid value	Description
Stroke	Round trip or one way	Setting travel mode of auto step
Loop time	0-100	Setting loop time of auto step
Step mode	Step point, percent, unit, default	Incrementing mode of auto step

Cycle interval	0-3600 seconds	Stop time between every cycle end and the next cycle start
Dwell time	0-3600 seconds	The time is pressure stable at each step
Step quantity	2-17	The number of steps
Range	Range will be based on the largest range of internal module	Setting auto step output range
Point list	Point list is read only except when "Custom" is selected for Step mode	Shows the pressure points of the auto step routine
Step value	6.25% to 100%	It can be set when the step mode is a percentage
Step value	Related to Auto Step Range and Step Points Range	It can be set when step mode is engineering unit

### 7. Manual step

- ◆ Press  /  or click  to go to manually step to output pressure.
- ◆ Click the middle number on icon  to set up manual step value.

### 3.2.2 Pressure measurement

1. Switch to pressure measurement status: High- or Low-pressure range

2. Connection: Refer to the Figure 4.

3. External pressurization

- ◆ Do not pressurize the calibrator beyond the measuring module range.
- ◆ When external pressure exceeds the current range, the value turns red and alarms at the same time.
- ◆ If the external pressure exceeds the maximum range, the system will immediately vent and prompt overpressure protection.



### 3.2.3 Pressure unit

◆ When the pressure output, pressure measurement or external pressure module is selected, click the pressure unit area on the screen to select a the desired unit.

### 3.3 Electrical signal measurement

The electrical signal measurement area provides such features as current measurement, voltage measurement, switch testing, HART communication and Profibus PA communication. Click the features icon and range at the left measurement area to switch the electrical measurement.

#### 3.3.1 Current/Voltage measurement

1. Click the input icons like  or  on the status bar to display the electrical measurement. Click the ranges area

on the screen to switch the current and voltages measurements.

- ◆ Do not apply current/voltage outside the calibrator's range.
- ◆ Short-circuit zeroing is allowed.
- ◆ If the measured value exceeds the present range, it will turn red and give an alarm.
- ◆ If the measured value exceeds the measurable range of calibrator, it will display red "-----" and give an alarm.

2. Connection: Connect the electric circuit as shown in Figures 9 and 10.

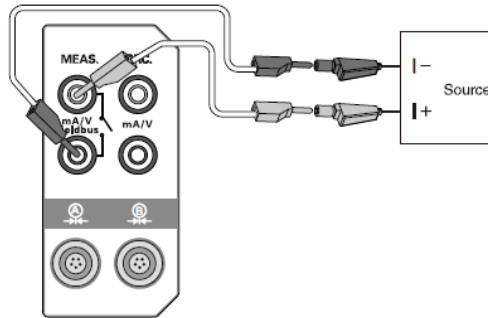

Figure 9 Current measurement

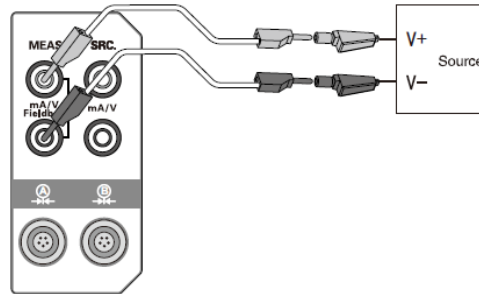

Figure 10 Voltage measurement

### 3. Functional operation

(1) Zeroing: Zero the measurement to eliminate the zero drift. The allowable zeroing range is 0.1%FS. For automatic mode, it will use the smallest range to calculate.

- ◆ (-30~30) V: calculate by (-5~5) V
- ◆ (-300~300) mV: calculate by (-300~300) mV
- ◆ (-50~50) mA: calculate by (-25~25) mA

(2) Scaling: Converts the current/voltage signals into pressure signal.

Table 11 Scaling parameters

Subject	Valid value	Description
Transfer function	Linear, square root, square	Type of the conversion function of the scaled

		value
Input range	0%~100%	Percentage of the input range of scaling
Unit	Depend on the electrical measurement selected	Input unit of scaling
Output range	0%~100%	Percentage of the output range of scaling
Unit	Pressure, temperature or electrical	Output unit of scaling
Resolution	1, 0.1, 0.01, 0.001	Resolution of scaling

(3) Filter: Provides a first-order linear filter and moving average filter. The moving average filter also allows to remove the extremum pair values.

Table 12 Filtering parameters

Subject	Valid value	Description
Filter type	First-order filter and average filter	Select the filtering mode.
Coefficient	0.01~1	Applicable to the first-order filter.
Filter sampling number	Integer 1~100	Sampling number of the average filter, correlated with the sampling time.
Filter sampling time	0~20 s	Sampling time of the average filter, correlated with the sampling number.
Extremum pair number	Integer 0~10	Extremum pair number of the average filter to be removed.

- (4) Resolution: Set digit resolution.
- (5) Stability: Set the stability of measurement.
- (6) Loop power supply: Applicable only for the current measurement. Select enabling/disabling loop power supply.

### 3.3.2 Switch test

1. Same as Para. 3.3.1, go to the electrical measurement options, click the range area on the screen, and select  for switch test. The calibrator can test three types of switches, i.e., mechanical switch, NPN electronic switch and PNP electronic switch.

#### 2. Connection

- ◆ If mechanical switch is selected, connect the electric circuit as shown in Figure 11.
- ◆ If NPN electronic switch is selected, connect the electric circuit as shown in Figure 12.
- ◆ If PNP electronic switch is selected, connect the electric circuit as shown in Figure 13.



Figure 11 Mechanical Switch

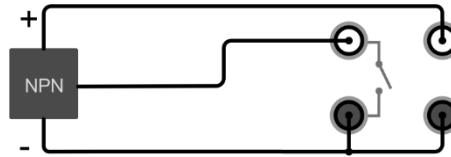

Figure 12 NPN Switch

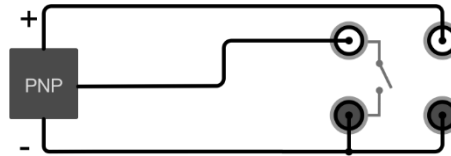

Figure 13 PNP Switch

### 3. Action value

- ◆ The switch action values are recorded only when the output item is pressure.
- ◆ Only a pair of action values is recorded, including the switch state (on to off/off to on) when triggered and pressure value.
- ◆ Press **\*\*\*** and select "Reset", to clear the action values.
- ◆ Press **\*\*\*** and select "Switch Setup", to switch between mechanical switch, NPN switch and PNP switch.

### 3.3.3 HART Communication

The calibrator supports HART bus communication, uses simplified files, and provides setting maintenance and calibration

for general and common parameters of HART pressure transmitters. Before using the calibrator to operate the transmitter, please refer to the user manual of transmitter. If you need full-featured HART operation, please refer to the Para. 7 "HART communicator".

Note: During communication with a HART device, the calibrator acts as a master station all the time. To avoid damaging the control system, you must separate the HART device from the control system before connecting the calibrator to HART device.

#### 1. Search and connection

◆ Under the main operation interface, open the electrical measurement area for display. Select  in mode switching to enable the HART function. The calibrator will automatically switch to power configuration selected previously (connection mode of internal power supply and internal resistance by default), and search for the address "0". When a HART device is found, the calibrator will automatically connect to it and display its reading.

◆ Press  and select "Search", or click the HART measurement channel screen when no HART device is connected, to enter the HART power configuration interface. The calibrator provides the following connection mode:

- 1) For the connection mode with internal power supply and internal resistance, see Figure 14.
- 2) For the connection mode with external power supply and external resistance, see Figure 15.
- 3) For the connection mode with internal power supply and external resistance, see Figure 16.
- 4) For the connection mode with external power supply and internal resistance, see Figure 17.



Figure 14 HART internal power / resistance

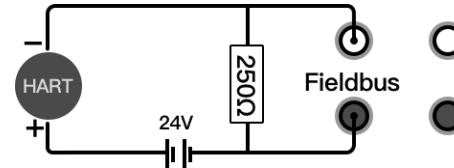

Figure 15 HART external power / resistance

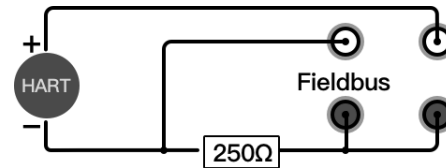

Figure 16 HART internal power / external resistance

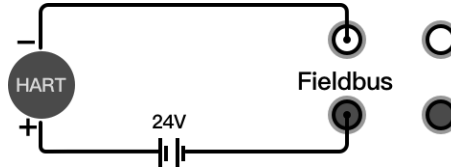









Figure 17 HART external power / internal resistance

- ◆ After the power supply configuration is selected, you will enter the search interface. Start searching HART devices from the address "0". After searched, the connection will be made and the HART device will be displayed. If no connection is established the calibrator will continue to search from the address "1" until "15". After the search is complete, the calibrator will list all the HART devices found, and can support at most 15 HART devices at the same time.

- ◆ During the search process, press the  key or  at top right to stop searching and return to the power configuration interface.

- ◆ During the search process, click  at top right to abort the search.

- ◆ After searched, you can press the  key to conduct a new search.

- ◆ After searched, if any HART device is online, press the  /  key to select it, then press the  key to confirm establishing connection with this device; press the  key and select "Setup" to read main information of the selected device.

## 2. Online/offline

- ◆ After connection is established, HART will be displayed as electrical measurement item on the main interface.

- ◆ Under the main interface, when electrical measurement is switched to other measurement mode (e.g. current measurement), it will exit HART connection. Meanwhile, the HART measurement icon in the status bar will change to a corresponding icon (e.g. current measurement).

- ◆ Under the main interface, if HART communication fails, it will automatically search new devices again.

- ◆ During a test with HART, the test will give a prompt if the HART is offline.

### 3. Process variables

- ◆ On the main interface, HART acts as an electrical measurement item. Press **•••** to enter process variables. It can display the primary variable PV, output current AO, percentage, secondary variable, third variable and loop current at the same time, in which the units of second variable and third variable are determined by different devices.

- ◆ In the process variables menu, press the / key or click the screen to select, and then press the  or  key for confirmation, so as to switch primary and secondary display.

- ◆ During task calibration of a HART transmitter, you shall first select the HART process variables to be calibrated.

### 4. Setup

#### (1) Parameters

- ◆ Under the main interface, switch to HART electrical measurement. Press **•••** to view and set HART parameters.

See Table 13.







Table 13 Hart Parameters

Subject	Parameter	Description and Valid value
Device	Label	Support input of letters, numbers and symbols, no longer than 8 characters.

information	Date	It can be modified to any date supported by the transmitter.
	Information	Support input of letters, numbers and symbols, no longer than 32 characters.
	Description	Support input of letters, numbers and symbols, no longer than 16 characters.
	Final assembly number	Support input of integers, no longer than 8 digits. (0~1677215)
	Pilot symbol number	Support input of integers from 5 to 20.
	Manufacturer	Read-only parameter
	Device type	Read-only parameter
	Device number	Read-only parameter
	Write protection	Read-only parameter
	Common version	Read-only parameter
	Software version	Read-only parameter
	Hardware version	Read-only parameter
Device version	Read-only parameter	
Sensor	Sensor S/N	Read-only parameter
	Sensor unit	Read-only parameter
	Lower sensor limit	Read-only parameter
	Upper sensor limit	Read-only parameter

	Minimum sensor range	Read-only parameter
Device output	Primary variable/range unit	It can be modified to any unit supported by the transmitter. During modification, the upper and lower limits are displayed through conversion.
	PV lower range limit	Not exceed the lower sensor limit.
	PV upper range limit	Not exceed the upper sensor limit.
	Transfer function	It can be modified to linear or square root.
	Damping	Device data filtering time, in the unit of S
	Polling address	0 by default, support input of integers from 0 to 15.
	Emergency mode	It can be set to Enable/Disable, depending on whether the transmitter supports it or not.
	Emergency command	The emergency command value can be set.
	Alarm status	Read-only parameter

## 2) Operation

- ◆ Under the HART setup interface, press the  key to view HART parameter values in real time; select a parameter that can be set, then press the  key or click the screen to enter the set state.
- ◆ After input is completed, press the  key or click  on the screen to save it; press the  key or click  on the screen to cancel saving and return.
- ◆ If the input value is displayed in red when saving, it indicates that the input value is invalid. Please check its input

---

range.

- ◆ If the present setting is cancelled or setup fails, the present item will be resumed.

## 5. Maintenance

### (1) Current loop test

- ◆ Click **\*\*\*** and select "Diagnosis/Service", to enter current loop testing. Use number keys to input or press the right side to select a test current value. Then press the  key to perform a current loop test. The value range of this parameter is 4-20 mA.

- ◆ The HART measured value at the left bottom of calibrator interface is the real value of current loop.

### (2) Primary variable zeroing

- ◆ Select "Zero" on the HART diagnosis/maintenance interface. Then select a pressure module to enter the zeroing interface.

- ◆ Ensure that the present measured value adequately approaches zero; otherwise, it may cause zeroing to fail.

### (3) Current regulation

- ◆ Adjust the proportion of current output of the transmitter, to make its AO value consistent with the actually output loop current.

- ◆ Provide regulation of the D/A zero (4mA) and D/A gain (20mA). You can press the screen to acquire the present value, and press the  key to perform regulation.

### (4) Sensor trim

Sensor trim is to adjust the PV process variable of the transmitter, generally including one or two trim points (lower

point and upper point). Some transmitters do not support the sensor trim operation (as for whether the transmitter supports sensor trim, please refer to the user manual of transmitter).

#### 1) Lower trim

Support setting the PV unit and trim point value. You can select two pressurization methods, internal and external pressurization. Press the  key to enter the execution interface.

Note: External pressurization requires an external pressure module.

- ◆ Internal pressure control: Select high-pressure and low-pressure modules, to automatically output the pressure of the trim points. Wait for the pressure to stabilize and press the "Get" key to directly acquire the value, or manually enter the trim values.
- ◆ External pressure control: Manually control the pressure of transmitter through an external source. Wait for the pressure to stabilize and press the "Get" key to directly acquire the value, or manually enter the trim values.



Note: Some transmitters may not allow selectable trim values, and automatically use the upper and lower range limits as trim values (the lower range limit corresponds to the lower-point trim value, and the upper range limit corresponds to the high-point trim value). In this case, you can input any value.

- ◆ Execute the adjustment (Trim) command. After completed successfully, the PV value will change with the executed trim point value.

#### 2) Upper trim

The operation procedure of upper trim is the same as that of lower trim.

#### 3) Factory reset

Select "Factory Reset", then a prompt will ask "Are you sure to restore factory settings of the sensor?" Press the  key or click  on the screen to execute the factory reset command. After completed successfully, the upper and lower

---

trim values will restore factory settings.

### 3.3.4 PROFIBUS PA communication



The calibrator supports PROFIBUS PA bus communication. It can set and calibrate the parameters of PROFIBUS PA pressure transmitter (PA transmitter). Before conducting any operation to the PA transmitter, you shall understand relevant terms of PROFIBUS PA protocol such as Physical Block, Transducer Block, Function Block, TARGET\_MODE, AUTO, OSS and Man. Before use, please refer to the user manual of transmitter.

Note: During communication with a PA transmitter, the calibrator acts as a master station all the time. To avoid damaging the control system, you must separate the PA transmitter from the control system before connecting the calibrator to PA transmitter.

#### 1. Device description (DD) file

The DD file is used to describe device parameters and parameter access modes. Through the parameter description information, you can view and set related parameters of the PA transmitter. The calibrator uses specific device description files, to access main parameters in the Physical Block, Transducer Block and Function Block of PA transmitter. This calibrator includes device description files of common mainstream PA pressure transmitters. If you need to add new device description files of transmitter, please contact us.

#### 2. Connection and search

- ◆ For the connection mode, please refer to Figure 14 in Para.3.3.3.
- ◆ Click the  icon to start searching; and click the  icon to stop searching.

- ◆ From the searched PA device list, click a PA device to be connected. After connection is successful, return to the main interface.

### 3. Process variables

Click  , then a function menu will pop up. Select "Process variables" in the function menu. The calibrator provides switching between display of process variables such as PRIMARY\_VALUE, SENSOR\_VALUE, SECONDARY\_VALUE\_1, TRIMMED\_VALUE, SECONDARY\_VALUE\_2 and STATIC\_PRESSURE\_VALUE.

### 4. Transmitter operation

#### (1) Setup

- ◆ After clicking  , a function menu will pop up. Select "Setup" in the function menu to enter the setup interface.
- ◆ On the setup interface, you can access and set parameters in the Physical Block, Transducer Block and Function Block.

- ◆ Before modification of some parameters, you may need to modify corresponding TARGET\_MODE (e.g. set it to OOS, Auto, Man, and so forth). Specifically, you can follow the user manual of PA transmitter to modify related parameters.

#### (2) Calibration

- ◆ Click  , then a function menu will pop up. Select "Calibration" in the function menu to enter the calibration menu.

- ◆ You can calibrate the PA transmitter on the calibration menu. Before performing calibration on the PA transmitter, please refer to relevant description of adjustment (Trim) part in the user manual of PA transmitter.

## 3.4 Electrical output

You can click a corresponding electrical output icon in the module display/hide operation area on the top status bar, to

display/hide the electrical signal output module. When the electrical output is displayed, the corresponding icon on the status bar will be highlighted. When the electrical output is hidden, the corresponding icon will be dim and when signals are being output, the output arrow on the icon will flicker.

### 1. Changing the range

Click the range area on the left side of the measurement area to switch the output item. The calibrator supports 0~25mA, 0~16V and 16~30V output.

2. Connection: Connect the electric circuit as shown in Figure 18.

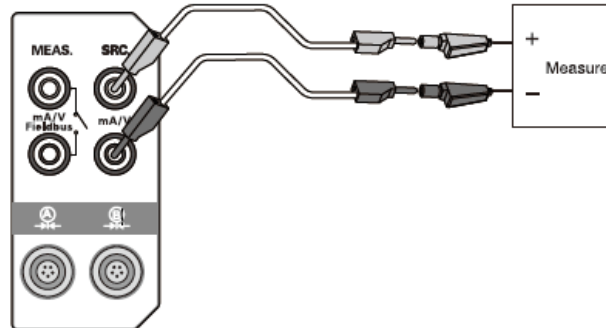







Figure 18 Current output of internal power supply

### 3. Enabling loop power (for current supply only)

- ◆ According to the connection mode, press the **•••** key and select whether to enable loop power.

- ◆ Power will be supplied as soon as loop power is enabled.

#### 4. Input of the target set value

◆ When the voltage output module is hidden, press the  key to enter the setup interface of electrical output values; when the voltage output module is hidden, press the  /  key or press the  key on the screen to realize step output of current, and set the step value inside the .

◆ The set value shall meet the calibrator's current output range of 0~25mA, voltage output range of 0~16V, and power supply output range of 16~30V.

#### 5. Auto step





Press the  key to enter the auto step setup. For the auto step parameters, see Table 14.

Table 14 auto step parameters

Subject	Valid value	Description
Stroke	Round trip or one way	Set the trip pattern of auto step.
Cycle number	0-100	Set the cycle number of auto step.
Step mode	Step point, percentage, value, or custom	Set the mode of automation step.
Cycle interval	0~3600 sec	Standing time between the end of each cycle and the start of next cycle.
Dwell time	0~3600 sec	Standing time after the present electrical output becomes stable.
Step point number	2-17	It can be set when the step mode is step point.

Range	Not to exceed the electrical output range.	Set the output range of automatic step.
Step point list	Editable when the step mode is custom; read-only and displayed under other modes.	Display the set point list of automatic steps.
Step value	6.25%~100%	It can be set when the step mode is percentage.
Step value	1.5625~25mA	It can be set when the step mode is value.

#### 6. Manual step

- ◆ Press the / key on the keyboard or  on the screen, to manually step through values.
- ◆ You can click the number inside  to set the step value of manual step.

#### 7. Ramp

Press the  key to enter the Ramp setup interface (only 0~25mA and 0~16V is applicable). For the Ramp output parameters, see Table 15.

Table 15 Ramp parameters

Subject	Valid value	Description
Range	Do not exceed the electrical output range	Set the ramp output range.
Rise time	1~60 sec	Ramp rise time
Fall time	1~60 sec	Ramp fall time



0% wait time	1~60 sec	Wait time of the slope at the lower range value.
100% wait time	1~60 sec	Wait time of the slope at the upper range value.
Repeat	0-100	Set the cycle number of slope. 0 indicates infinite repetition.

### 3.5 External pressure module

1. Connection: Connect the external pressure module as shown in Figure 19.

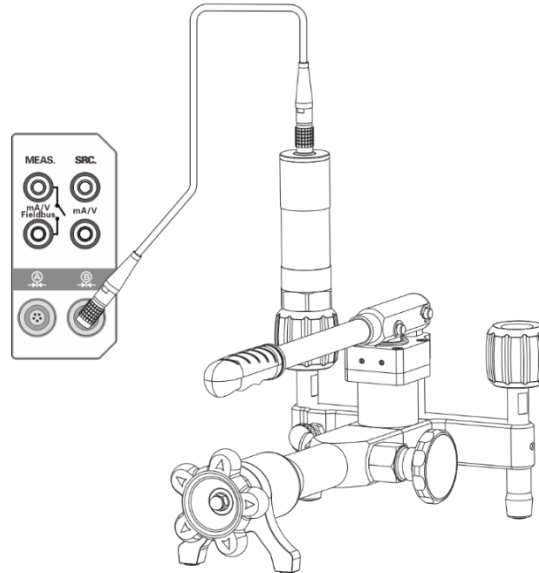

Figure 19 Connection of the external module

## 2. Display of the external pressure module

◆ When the pressure module is connected properly, the status bar will display the online icon of pressure module. The calibrator supports two external pressure modules A and B, and provides multi-screen display with other features.

When the external pressure modules A and B are both connected, the calibrator can show up to five channels in the multi-screen.

- ◆ If the measured value exceeds the present range of pressure module, it will turn red and give an alarm.
- ◆ If the measured value exceeds the measurable range of pressure module, it will display red "-----" and give an alarm.

### 3. Related operations of external pressure module

- ◆ The pressure unit can be switched.
- ◆ Press **•••** to enter the function menu. Select "Stability", to set the stability time and stability.
- ◆ Zeroing is allowed.
- ◆ Select "Module Information", to view related information of the external pressure module.
- ◆ Select "Resolution", and set the number of digits displayed to 4, 5 or 6.
- ◆ Select "Filter". Then, you can select first-order filter or average filter as the filter type, and set related parameters.

## 3.6 Typical applications on main page

### 3.6.1 Pressure gauge calibration

#### 1. Prepare

- ◆ Go to the pressure output area of main operation interface:
- ◆ Select High-pressure or low-pressure range (depend on the range of calibrated instrument).

#### 2. Connection

- ◆ Connect the gauge as shown in Figure 20 (dial pressure gauge)/21 (digital pressure gauge).

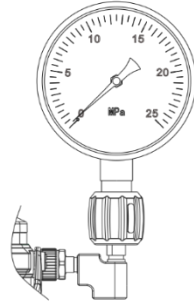

Figure 20 Connect a dial pressure gauge

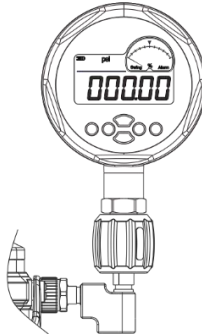

Figure 21 Connect a digital pressure gauge

3. Manually set or use the step function (see Para. 3.2.1 "Auto step and manual step of pressure output") to output the pressure of each calibration point.
4. When the pressure of each calibration point becomes stable and is displayed in green, record the readings of each point.

### **3.6.2 Pressure transmitter Calibration**

The calibrator supports calibration of 2-wire, 3-wire and 4-wire pressure transmitters.

#### 1. Prepare

- ◆ Select the pressure output in menu.
- ◆ Open the pressure output area of main operation interface: High-pressure or low-pressure range (depends on the range of the transmitter).
- ◆ Switch the electrical measurement item of main operation interface to: Current or voltage measurement (depend on the output signal of the transmitter).
- ◆ If the current-type 2-wire pressure transmitter needs loop power supply, you shall enable loop power supply in the current function menu.

#### 2. Connection

- ◆ For 2-wire pressure transmitter connect as shown in Figure 22.
- ◆ For 3-wire pressure transmitter, connect as shown in Figure 23.
- ◆ For 4-wire pressure transmitter, connect as shown in Figure 24.

- ◆ If the transmitter is a differential pressure transmitter, you shall connect the REF port properly.

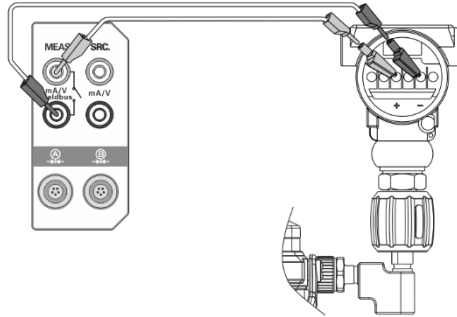

Figure 22 Calibration of a 2-wire pressure transmitter

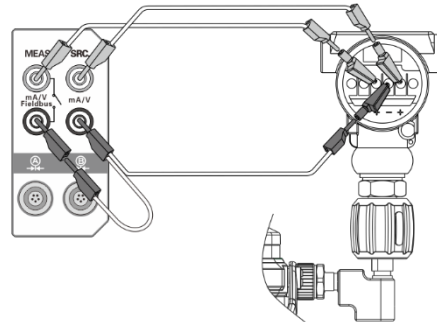

Figure 23 Calibration of a 3-wire pressure transmitter

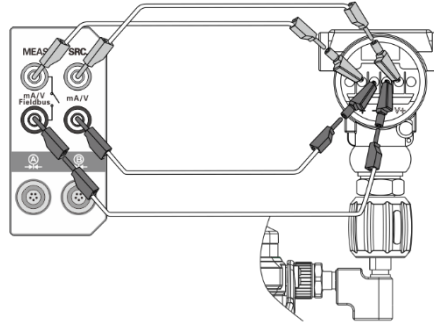

Figure 24 Calibration of a 4-wire pressure transmitter

3. Manually set or use the step function (see Para. 3.2.1 "Auto step and manual step of pressure output") to output the pressure of each calibration point.
4. When the pressure of each calibration point becomes stable and is displayed in green, record the output value of the transmitter at each point, or use the snapshot feature.

### 3.6.3 HART transmitter calibration

#### 1. Prepare

- ◆ Select the pressure output in menu.
- ◆ Open the pressure output area of main operation interface: High-pressure or low-pressure range (depends on

---

the range of the transmitter).

- ◆ Switch the electrical measurement item of main operation interface to: Current measurement.

## 2. Connection

- ◆ Connect the hydraulic circuit as shown in Figure 4; connect the electrical circuit as shown in Figure 14-17.

3. Make connection (see Para. 3.3.1). During setup, switch the process variable to current output.

4. Press the Setup icon, to set the parameters of the HART transmitter (see Para. 3.3.3).

5. Press the Setup icon, to configure the process variable of the HART transmitter (see Para. 3.3.3).

6. Manually set or use the step function (see Para. 3.2.1 "Auto step and manual step of pressure output") to output the pressure of each calibration point.

7. When the pressure of each calibration point becomes stable and is displayed in green, record the output value of the HART transmitter at each point, or use the snapshot feature

### 3.6.4 Pressure switch calibration

#### 1. Prepare

- ◆ Open the pressure output area of main operation interface.
- ◆ Select the High-pressure or low-pressure range (depends on the range of the switch)
- ◆ Switch the electrical measurement item of main operation interface to: Switch measurement.

#### 2. Connection

- ◆ Connect the switch as shown in Figure 25 (it is a mechanical switch in the figure. If the tested switch type is NPN or PNP electronic switch, please connect the electric circuit as shown in Figure 12 or 13).

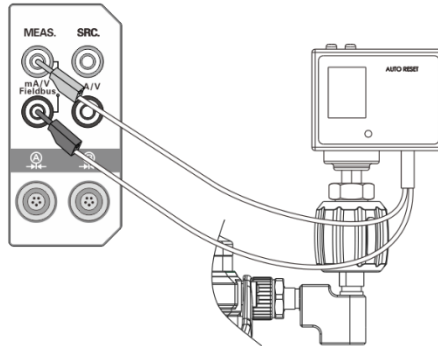

Figure 25 Calibration of a pressure switch

### 3. Capture of the action value

- ◆ To capture more accurate action values, you can enter "control settings" and set the slew rate to a lower value which will reduce the lag time.

- ◆ Separately use the upper and lower range limits of switch as the target value for pressure control until the switch acts. Then, capture and display the action value.

4. Record the captured action value or use snapshot storage (it can store a pair of action values at the same time).

### 3.6.5 I/P converter

#### 1. Prepare

- ◆ Switch the electrical output item of main operation interface to: Current output.
- ◆ Open the pressure output area of main interface and switch to the measurement state: High-pressure or low-pressure range (depends on the range of the I/P converter).
- ◆ The output pressure of I/P converter can be measured by using an external pressure module.

## 2. Connection

- ◆ Connect as shown in Figure 26.

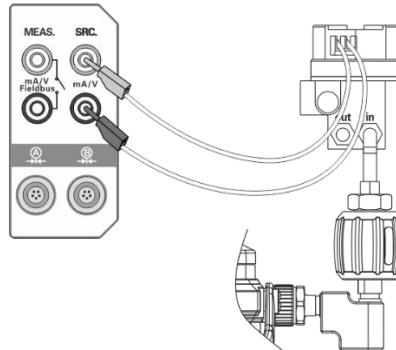

Figure 26 Calibration of an I/P converter

- ◆ Never apply pressure out of the present range of the calibrator.
- ◆ Never use the calibrator for pressurization.



◆ If the loop power supply of calibrator is used (the maximum load is 50 mA), please check the load capacity.

3. The I/P converter shall use the manual or automatic step function of electrical output (see Para. 3.4 Electrical output), to successively output current of each calibration point.

4. When each measured pressure value becomes stable, record the output value of I/P converter at each point, or use the snapshot feature.

---

## 4. Setup

Under the main interface, press the  key to enter the system setup interface. Or click  on the screen, then a main menu will pop up. Select "Set up" on the main menu to enter the system setup interface. System setup includes control setting, communication, power management, calibration, service, personalization, cloud service, data management and product information.

### 4.1 Control settings

#### 1. Pressure type

- ◆ It supports gauge pressure and cannot switch to others.

#### 2. Control rate limit

- ◆ If disabled, the calibrator will approach the target value at the maximum control speed.
- ◆ If enabled, you need to set an upper slew limit. During pressure control of the calibrator, the maximum control speed shall not exceed this limit.

#### 3. Stability

- ◆ Input the pressure stability: One of pressure stability conditions. Compare the difference between the output pressure and set pressure with this value. Its range is  $\pm(0.005\sim 1)\%FS$ .

#### 4. Stabilization time

- ◆ Input the pressure stabilization time: One of pressure stability conditions. Pressure control is considered stable when the difference between the output pressure and set pressure meets requirements and lasts for this duration. Its range is 1~60sec.

- ◆ The pressure can be judged stable when the following two conditions are met during control:

1)  $(\text{Out put pressure} - \text{set pressure}) \leq \text{High-pressure/low-pressure range} \times \text{pressure stability}$

2) Meet the condition 1) continuously and reach the pressure stabilization time.

#### 5. Automatic zero

- ◆ Can be enabled or disabled.
- ◆ If enabled, the calibrator will automatically perform pressure zeroing when vented to the atmosphere.

#### 6. Vent pressure

- ◆ Allowable setting range of the vent pressure: Depend on the device model.
- ◆ Press the “Vent” key to vent. If the pressure is lower than this value, the calibrator will open the vent valve to the atmosphere. If the pressure is higher than this value, the calibrator will control the pressure to this value and then open the vent valve to the atmosphere.

#### 7. Head correction

- ◆ The correction type can be selected from: auto or fixed.
- ◆ Correction value: when correction type is set to fixed, input the correction value here.
- ◆ The unit can be selected from: Metric (SI) or Imperial (BS)
- ◆ The density can be selected from: deionized water, Sebacate oil or user-defined value;
- ◆ The Head correction can be input within the range of (-1000~1000) cm.
- ◆ The acceleration can be input within the range of (9~10)  $\text{m/s}^2$ .
- ◆ Zero return: disabled/ enabled.

#### 8. Set point limit

- ◆ Input a range smaller than the calibrator range as the upper and lower limits of pressure control, to ensure that the pressure output to the UUTs does not exceed its range, thereby protecting the UUTs.
- ◆ If disabled, this function is invalid. The setting will be stored by the calibrator and still effective after reboot.
- ◆ If enabled, the target value of pressure control of the calibrator is limited by this condition. When exceeding this condition, the calibrator will give a prompt that the set point limit is enabled and the set pressure cannot be output.

#### 9. Medium type

- ◆ Medium type of this ADT762 unit, deionized water (ADT762W) or Sebacate oil.
- ◆ This is set in factory and cannot be changed.

## 4.2 Communication

The calibrator supports four communication modes: Ethernet, Wi-Fi, Bluetooth (BLE) and USB port.

### 4.2.1 Ethernet

The calibrator is connected via network cables to computers for communication.

Table 16 Network connection

Subject	Valid value	Description
Address acquisition	DHCP/Static	Select the acquisition mode of device address.

- ◆ When the DHCP mode is selected, the content of the table below will be allocated by the system automatically

and are read-only items.

- ◆ When the static mode is selected, the following table needs to be completed manually.

Table 17 Static mode selection

Subject	Valid value	Description
I/P address	0.0.0.0~255.255.255.255	Set the IP address of calibrator host.
Subnet mask	0.0.0.0~255.255.255.255	Set the subnet mask of calibrator host.
Gateway	0.0.0.0~255.255.255.255	Set the source gateway of calibrator host.

- ◆ The port number and physical address are factory settings and cannot be modified.
- ◆ Click the  button at the lower right corner of screen confirms and saves the settings.

#### 4.2.2 Wireless communication

The calibrator is connected via a wireless network.

Table 18 Wireless network selection

Subject	Valid value	Description
WLAN	Open/Close	Open or Close the WLAN
Advancec options	DHCP/Static	Select the device address acquisition method
SSID	Depends on network environment	Wireless network access point selection

- ◆ The port number and physical address are factory settings and cannot be modified.

- ◆ When the static mode is selected in advanced options, the following table needs to be completed manually.

Table 19 Setup of wireless communication

Subject	Valid value	Description
I/P address	0.0.0.0~255.255.255.255	Set the IP address of calibrator host.
Subnet mask	0.0.0.0~255.255.255.255	Set the subnet mask of calibrator host.
Gateway	0.0.0.0~255.255.255.255	Set the source gateway of calibrator host.

- ◆ Click the  button at the lower right corner of screen to confirm and save the settings.

◆ The setting of wireless communication will take effect immediately, with no need for confirmation. Click  at the upper right corner of screen, to return to the previous menu.

### 4.2.3 Bluetooth

The calibrator is connected through Bluetooth to mobile APPs for communication.

Table 20 Bluetooth setup

Subject	Valid value	Description
Bluetooth state	Enable/disable	Enable or disable the Bluetooth function.
Bluetooth name	Support Chinese characters, letters, numbers or symbols.	Set the Bluetooth name of calibrator.



---

Physical address	Read-only	
------------------	-----------	--

#### 4.2.4 USB port

Table 21 USB serial setup

Subject	Valid value	Description
Baud rate	9600, 19200, 38400, 57600, 115200, custom	Baud rate for communication
Parity bit	None, Odd, Even, Mark, Space	Verification method
Data bit	5, 6, 7, 8	Data bit set
Stop bit	None, One, Two, One Point Five	Stop bit set

#### 4.3 Power management

##### 4.3.1 Display brightness

The LCD brightness of calibrator can be modified by adjusting the brightness progress bar.

##### 4.3.2 Battery information

Display the present connection state and information of the battery.

### 4.3.3 Energy settings

The energy settings can prolong the service life of the battery by setting the auto-backlight time, auto-sleep time and auto-shutdown time.

#### 1. Backlight time

- ◆ In case there is no key and serial port command operations within a set time, the backlight brightness will be automatically set to the lowest value.

- ◆ There are 6 types of setting: never, 30 sec, 1 min, 5 min, 15 min, and 30 min.

- ◆ When the backlight is turned off, the first keypress will resume the backlight brightness, only after which subsequent key-pressing can take effect normally.

- ◆ During pressure control, auto step or task execution, this function does not take effect.

#### 2. Auto sleep

- ◆ In case there is no key and serial port command operations within a set time, it will automatically sleep.

- ◆ There are 4 types of auto-sleep setting: never, 1 min, 5 min and 30 min.

- ◆ If connected to a power adapter, the calibrator does not support auto sleep.

- ◆ During pressure control, auto step or task execution, this function does not take effect.

- ◆ When the backlight off time is set to "never", the auto-sleep setting is invalid.

#### 3. Auto power off

- ◆ In case there is no key and serial port command operations within a set time, it will automatically shut down.

- ◆ There are 5 types of auto power off settings: never, 5 min, 15 min, 30 min, 1 hour and 2 hours.

- ◆ If connected to a power adapter, the calibrator does not support auto power off.
- ◆ During pressure control, auto step or task execution, this function does not take effect.
- ◆ When the backlight off time or auto sleep time is set to "never", the setting of auto power off is invalid.

#### 4.4 System calibration

- ◆ The electrical measurement, electrical output and internal pressure modules of this calibrator all need periodic calibration.
- ◆ This calibrator can also provide calibration for external pressure.
- ◆ Before calibration, please carefully read the user manual, and perform operation after you have understood it.
- ◆ Improper calibration will affect the accuracy of calibrator, and in severe cases, may affect normal working of the calibrator.
- ◆ Provided is a factory reset function to restore calibration data to factory settings. When performed the calibration date is restored to "---/--/--".
  - ◆ You need to use a standard device with higher accuracy for calibration.
  - ◆ On the setup interface, enter system calibration and select an item to be calibrated.
  - ◆ To avoid mis-operation, this operation needs a password for confirmation. The password is "123456".
  - ◆ After the calibration of the last point is completed, confirm and save it. The new calibration data will take effect and be used. The former calibration data will be deleted permanently.
  - ◆ The calibrator provides a calibration due date warning.







---

#### 4.4.1 Calibration of electrical measurement

##### 1. Set the calibration points

- ◆ Several calibration points are provided by default according to the electrical measurement range of the device.
- ◆ The calibration points can be modified. Please do not exceed the range given by the system. Except under special circumstances, modification is not suggested.

##### 2. Perform calibration

- ◆ Press the start icon at the right bottom of screen or press the  key to start calibration.
  - ◆ According to the calibrator's prompt, make the standard current/voltage source successively output standard current/voltage of each calibration point to the calibrator. Until the measured value becomes stable, press the  icon on the right side of screen or press the  key to record and continue.
    - ◆ Before final completion of calibration, you can return to the previous operation by using the  icon or  key anytime, until exiting the entire calibration function. This calibration will not take effect.
    - ◆ If the measured value deviates greatly from the calibration point, it will give a prompt.
    - ◆ After calibration is completed, it will take effect immediately.
- ##### 3. Restore the factory calibration data.
- ◆ Click  on the right side of screen, to restore the factory data.

#### 4.4.2 Auto tune

Auto tune can optimize controller parameters which have reduced after long-term use, so as to improve the pressure control stability and efficiency, as shown in Figure 27 to plug the output port directly before Auto tune.

Caution: Please seal the pressure outlet. Auto tune is necessary only when the pressure controlling of the unit is not performing to specification. Incorrect or unnecessary auto tune may influence the control performance. Please carefully use this function.

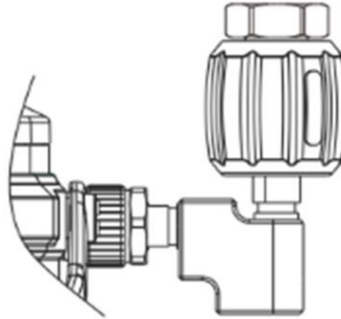

Figure 27 Auto tune connection

#### 4.4.3 Calibration of the pressure source module

The internal pressure control module is used to calibrate the pump source pressure sensor, booster front pressure sensor,

---

etc. inside the calibrator to correct the pressure drift caused by the long-term operation of the internal sensor, and the pressure outlet needs to be closed during execution.

#### 4.4.4 Calibration of the pressure module

##### 1. Hydraulic connection

- ◆ Check the internal pressure module to choose internal pressure or external pressure mode;
- ◆ When selecting the internal pressurization mode, please connect the pressure output port of the calibrator to a reference pressure instrument;
- ◆ When selecting the external pressure mode, please connect the calibrator to the standard pressure output liquid circuit;
- ◆ When calibrating an external pressure module, if the pressure range of the internal pressure source covers the pressure module to be calibrated, internal or external pressure can be selected. When not covered, only external pressurization can be selected.

##### 2. Set calibration point

- ◆ Calibrate the pressure modules via two-point or multi-point calibration based on the quantity and range of the modules.
- ◆ The calibration point can be changed, please make sure that the input calibration point set value is within the range of the internal pressure module and ensure that the first point is smaller than the subsequent points. It is not recommended to change it usually.

##### 3. Perform calibration

- (1) Click  to calibrate;

(2) Internal control:

According to the prompt of the calibrator, the calibrator outputs the pressure to the standard device. After the pressure is stabilized, click the reference value corresponding to the calibration point, and input the pressure readout of the reference gauge. After confirming, click  to go to the next point;

(3) External control:

According to the prompt of the calibrator, the pressure is output from the standard to the calibrator. After the pressure is stabilized, click  to do the next point calibration.

Note: Please adjust the reference gauge pressure output to be the same as the set value of the calibrator.

(4) If the measured value deviates too much from the calibration point, there will be a prompt

(5) After the calibration is successful, the new calibration data will take effect immediately, and the calibration date will become the current system date

4. Restoring factory calibration data

Click on the right side of the screen the  button can be restored to factory calibration data.

#### 4.4.5 Calibration Expiration Reminder

You can set the calibration expiration date of each module and set whether to turn on the expiration reminder function of each module. The default calibration period is 365 days. When a specific module of the calibrator has exceeded the calibration period, a prompt will be given when the calibrator is powered on or when the module is online . You can turn on/off the reminder function or modify the calibration period in the calibration expiration reminder settings interface

## **4.5 Services**

### **4.5.1 Firmware upgrade**

The calibrator provides a function of firmware upgrade. The upgrade operation includes two types: Local upgrade via a USB flash drive or remote upgrade.

#### 1. Local upgrade via a USB flash drive

1) Copy the upgrade file under the root directory of USB flash drive (ensure that the format of USB flash drive is FAT16 or FAT32).

2) After power-on, insert the USB flash drive into the USB-A port on the left side of calibrator.

3) Select "Upgrade via USB" on the upgrade interface.

4) Click ✓. The calibrator will analyze the upgrade file and display information that it is going to upgrade. After confirmation, the system will start automatic upgrade.

5) Wait for several minutes until the upgrade program is finished. The system will automatically display the upgrade result. After confirmation, the system will reboot automatically.

#### 2. Remote upgrade

1) You can manually check the latest firmware version or start automatic upgrade.

2) Remote upgrade shall ensure that the calibrator can be connected to the Internet through LAN Ethernet or Wi-Fi.

### **4.5.2 Maintenance**



Maintenance needs inputting a password. The factory default password is: 123456

- ◆ Maintenance is used to record the maintenance records, calibration records, and system board replacement information of the device; and can also execute operation to clear system records.
- ◆ Maintenance records: Users can add the maintenance personnel, date, content and brief information, which is displayed in the form of list.
- ◆ Calibration records: Record related information of each calibration, including the calibration item, calibration time, and detailed calibration data. Users can search and browse it by date and time.
- ◆ System log: factory exception log, clear system log and overpressure record of the pressure module.
- ◆ Data export: DB file export of tasks, etc.
- ◆ Advanced settings: Filter settings of the control module, setting and enabling of the power-on password, liquid level power-on reminder switch, zero return settings etc.
- ◆ Process diagnosis: Including self-diagnosis of some functional modules in the equipment, which is used for fast locate the problem in case of malfunction.

### 4.5.3 Factory reset

Factory reset requires a password. The factory default password is: 123456. After reset, data cannot be retrieved. Please carefully use this function.

- ◆ Restores the user settings to defaults, and clear snapshot and task files.
- ◆ Inputs the password to enter the factory reset interface. A prompt box will pop up to ask whether you confirm it.

Click "OK" or press the  key to immediately execute the reset operation. Click "Cancel" or press the  key to cancel operation.

- ◆ Factory reset will not restore system calibration data. If you need to restore the system calibration data, please

---

refer to Para. 4.4 "System calibration".



- ◆ After factory reset and reboot, users need to set the date/time. See Para. 4.6.1.

#### 4.5.4 Pressure release

##### 1. Function introduction

It is used to release the pressure inside the output terminal and the instrument, generally before maintenance and shutdown.

##### 2. Operating procedures



- ◆ After entering the application, click  button to enter the maintenance and draining process, you can click the  button to stop in the middle.
- ◆ Waiting for the progress to complete, a pop-up window prompts.

#### 4.5.5 Liquid Exhaust

##### 1. Function introduction

The liquid exhaust function can reduce the air in the liquid circuit, thereby increasing the load capacity of the equipment (for the same compression stroke, the less gas in the pipeline, the greater the pressure generated, and if possible, it's better to put the output port and UUT upside down to obtain a more significant gas purging effect).

##### 2. Operating procedures

- ◆ After entering the application, enter the maximum range of the unit, and click  go to the next step;
- ◆ Click  Entering the exhaust process, you can exhaust multiple times according to the prompts.

#### 4.5.6 Liquid change

##### 1. Function introduction

The liquid change function is used for draining the medium in the unit, and then new medium can be added, or other operations can be performed. This process needs human operations involved to control the start and stop of the function. It can set a reminder of liquid change; the default notification interval is 30 days or 80 hours of the pump running.

##### 2. Operation

- ◆ In case of the pressure is too high, vent it at first. Click  and wait the vent finishes, then refer to Figure 28.
- ◆ Follow the steps in Figure 28 to prepare for the liquid replacement.
- ◆ Click  button to drain, click  button to stop draining.

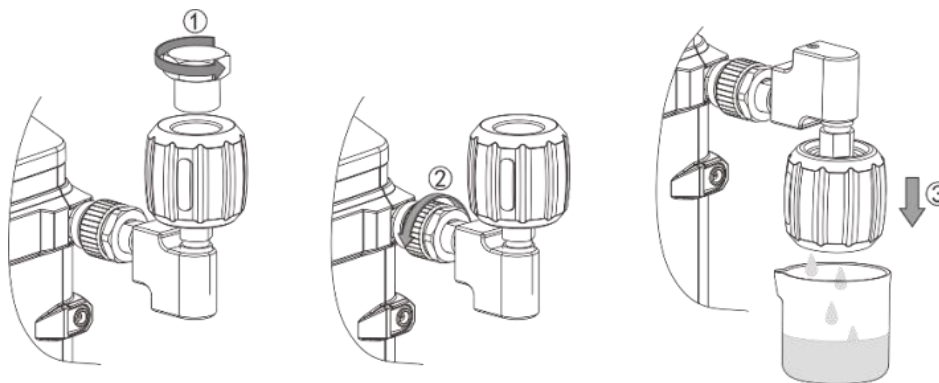

Figure 28 Prepare for liquid replacement when vented



#### 4.5.7 Piston maintenance

##### 1. Function introduction

This function is a preliminary treatment when the piston has malfunction. Perform the piston maintenance regularly to keep it in good condition, so as to extend the unit's life; Set the notification for due date in the setting, the default interval is 30 days.

##### 2. Operation

Caution: Please seal the pressure outlet port before start.

- ◆ Click  button to start piston maintenance.
- ◆ Click  button to stop piston maintenance.

#### 4.5.8 Accumulator replacement

##### 1. Function introduction

When the accumulator pressure is too low, it can affect the normal operation of the unit. It is necessary to replace the accumulator promptly to ensure the functions optimally. When the unit detects that the accumulator pressure does not meet the required level, a warning icon will flash and a pop-up alert will appear.

##### 2. Operation

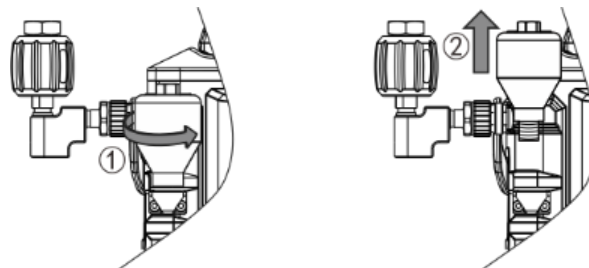

Figure 29 Disassembling the accumulator

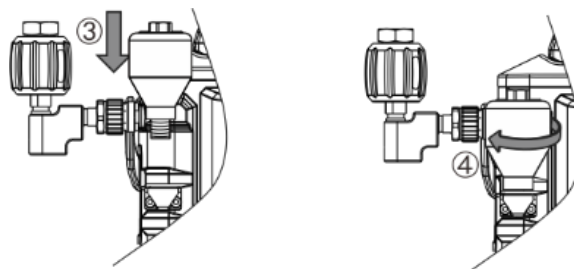

Figure 30 Install the accumulator

- ◆ Turn on the unit.
- ◆ Before inflating the accumulator, can click "Retest" to test the pressure of the accumulator.
- ◆ Click the ► button to enter the pre-replacement preparation steps for the accumulator. Wait for the process to complete and automatically start the accumulator replacement procedure.
- ◆ First, disassemble the accumulator from the unit (steps shown in Figure 29).
- ◆ After disassembly, install the new accumulator (installation steps shown in Figure 30).
- ◆ Click the ► and ◀ buttons to switch steps, follow the prompt steps to operate.
- ◆ After replacement, click ► to retest the accumulator pressure and ensure the new accumulator meets the requirements.

## 4.6 Personalization

Personalization includes date and time, language, and sound settings.

### 4.6.1 Date and time

Table 22 Date and time

Subject	Valid value	Description
Time	00:00~23:59	Set the time.
Date	2000-1-1~2099-12-31	Set the date.

Date format	Year-month-day/month-day-year/day-month-year	Set the date format.
Separator	-, /	Set the date separator.

#### 4.6.2 Language

The device provides multi-language interfaces. You can select a suitable language interface through this menu.

- ◆ When selected, the language interface will take effect after rebooting the device.

#### 4.6.3 Sound

Table 23 Sound setup

Subject	Valid value	Description
Volume	Volume setting in the form of a progress bar	Set the device volume.
Touch sound	On/off	Enables/disables the sound for the touch screen display.
Prompt sound	On/off	Enables/disables the prompt sound
Over-range warning sound	On/off	Enables/disables the sound for over-range warning
Snapshot sound	On/off	Enables/disables the sound for when a snapshot is taken

#### 4.6.4 CSV file

For set the CSV files. At present it can be set to “.” or “,”.

#### 4.7 Cloud service

1. Provided through Ethernet or Wi-Fi methods for connection to the ACloud service. Through Additel Link (providing several client modes such as mobile APP and PC), users can monitor the real-time operation status and data of the device anytime anywhere.



2. After the cloud service is enabled, the top status bar of main interface will display a cloud service state icon  or , respectively indicating that connection to the cloud service succeeded or failed.

Table 24 Setup of cloud service

Subject	Valid value	Description
Enable	On/off	Enable or disable the cloud service function.

#### 4.8 Data management

◆ Perform management by function modules. Data management of each function is under the corresponding item, it's for user convenience.

- ◆ Functions that can save data files include: Snapshot, pressure leakage test, data logging, etc.
- ◆ Users can export data in the format of CSV through a USB flash drive or PC software.
- ◆ Users can delete data in batches.

## **4.9 Product information**

The product information includes calibrator host information, control board information, electrical measurement board information, electrical source board information, wireless module information, Profibus module information and HART communicator information.

### **4.9.1 Host information**

◆ Includes the model, serial number, host version, system firmware version, system hardware version, power-on times, operation time, etc. Generally, the firmware version refers to host version. When contacting customer service, please provide this information.

### **4.9.2 Control board information**

- ◆ Includes the software version and hardware version of control board, and the parameters of internal pressure module.
- ◆ The parameters of internal pressure module include: Model, range, S/N and calibration date.

### **4.9.3 Electrical measurement board information**

- ◆ Includes the software version and hardware version of electrical measurement board, as well as current and

voltage measurement parameters.

- ◆ The current and voltage measurement parameters include: Range, accuracy and calibration date.

#### **4.9.4 Electrical source board information**

◆ Include the software version and hardware version of electrical source board, as well as the current and voltage parameters of electrical output.

- ◆ The current and voltage sourcing parameters include: Output range, accuracy and calibration date.

#### **4.9.5 Wireless module information**

- ◆ Include the Wi-Fi version, Bluetooth version, etc.

#### **4.9.6 PROFIBUS module information**

◆ Include the firmware version and hardware version of PROFIBUS module. The PROFIBUS module is used to realize related functions of communication with transmitters.



#### **4.9.7 HART communicator information**

Includes the DD library version, etc.

---

## 5. Documenting Tests

### 5.1 Quick test

Click the main menu icon  on the main interface, and then select the icon  to enter the quick test function, and the calibrator displays the test type list. The quick test function doesn't require test information to be entered in advance.



#### 5.1.1 Pressure gauge



Select the "pressure gauge" icon  in the test type list to start the quick test of the pressure gauge.

##### 1. Connection



- ◆ Connect as shown in Figure 20 when testing a dial pressure gauge;
- ◆ Connect as shown in Figure 21 when testing a digital pressure gauge.

##### 2. Start the test

- ◆ Click the zeroing button  to reset the pressure control module.
- ◆ Click the start button  to select the automatic execution to enter the execution parameter setting interface. Input the set point list, the number of cycles, the stroke mode, the number of readings, the reading interval, and the dwell time, and then click the OK button  to start the test. The test data will be manually entered at each point of the test.

- ◆ Click the next button  to skip the current test point and enter the next test point.
- ◆ Selecting manual perform and then start the test. It requires enter new test points after entering each reading.
- ◆ To stop this test, click the return button .

### 3. Save the result

- ◆ Click the save button  to save the test result.
- ◆ The following information is required: Name and serial number. Then click the check mark in the lower right corner to save the results.
- ◆ To exit and without saving, press the return button .
- ◆ To redo the test, click the reset button .





### 5.1.2 Pressure transmitter

Select the “pressure transmitter” icon  in the test type list to start the quick test for pressure transmitter.

#### 1. Connection





Refer to Para. 3.6.2 for connection.

#### 2. Start the test

- ◆ Click the zeroing button  to reset the pressure control module.
- ◆ Click the start button  to select the automatic execution to enter the execution parameter setting interface. Fill in the set point list, the number of cycles, the stroke mode, the number of readings, the reading interval, and the dwell time, and then click the OK button  to start the test.
- ◆ Selecting manual perform and then start the test. After the set point is stabilized, it is required to click the next point button  to collect data and then input the new set point.

- ◆ To stop this test, click the back button .

### 3. Save the result

- ◆ Click the save button  to save the test result.
- ◆ The following items need to be entered: Name and serial number, click OK button  to save the test results.
- ◆ To exit without saving press the back button .
- ◆ To redo the test, click the reset button .





## 5.1.3 Pressure switch

Select the “pressure switch” icon  in the test type list to start the quick test.

### 1. Connection

- ◆ Connect the switch as shown in Figure 25.





### 2. Start the test

- ◆ Click the zeroing button  to reset the pressure control module;
- ◆ Click the start button  to select to enter the execution interface;
- ◆ Select the graph display button  and the table display button  to switch between the graph display or table display.
- ◆ Pressure switch action: When the internal pressure module is used as the reference, it will be automatically run the test. When the external pressure module is used as the reference, manual pressure generation is required and the

switch data will be recorded.

- ◆ To stop this test, click the return button .

### 3. Save the result

- ◆ Click the save button  to save the test result.
- ◆ The following items need to be entered: Name and serial number, click OK button  to save the test results.
- ◆ To exit without saving, press the return button .
- ◆ To redo the test click the reset button .

## 5.1.4 Pressure sensor

Select the “pressure sensor” icon  in the test type list to start the quick test.

### 1. Connection

Connect the sensor as shown in Figure 29.

### 2. Start the test

Same as Para. 5.1.2 Pressure transmitter.

### 3. Save the result

Same as Para. 5.1.2 Pressure transmitter.

## 5.1.5 I/P converter

Select the “I/P converter” icon  in the test type list to start the quick test.

---

1. Connection

- ◆ Connect as shown in Figure 26.

2. Start the test

Same as Para. 5.1.2 Pressure transmitter.

3. Save the result

Same as Para. 5.1.2 Pressure transmitter.

### 5.1.6 Signal isolator

Select the “signal isolator” icon  in the test type list to start the quick test.

1. Connection

- ◆ Connect as shown in Figure 30.

2. Start the test

Same as Para. 5.1.2 Pressure transmitter.

3. Save the result

Same as Para. 5.1.2 Pressure transmitter.





### 5.2 Task

The calibrator provides task functions which automate preset calibration routines, and collect, record, and save test data.

- ◆ Enter the task interface: Click , and select the task in the menu .

- ◆ Task list interface: Click  on the right side of the screen to create a new task, click  to delete tasks, and

click  to create a new folder.

◆ Test parameter interface: Click  on the right side of the screen to delete the task, click  to edit the task, click  to copy the task, and click  to start the task.

### 5.2.1 Dial pressure gauge

#### 1. Connection

◆ Connect the calibrator and the dial pressure gauge as shown in Figure 20.

#### 2. New task

Select the “Dial pressure gauge” icon  in the test type list and input the information of the pressure gauge.

Table 25 Task mode dial pressure gauge information

Subject	Valid value	Description
Name	Letter, numeral, symbol	Name of the pressure gauge
Serial number	Letter, numeral, symbol	Serial number of the pressure gauge
Model	Letter, numeral, symbol	Model of the pressure gauge
Pressure type	Gauge pressure, absolute pressure, differential pressure	Pressure type of the pressure gauge
Range	Depends on the pressure gauge	Range and unit of the pressure gauge
Accuracy	0.06%, 0.1%, 0.16%, 0.25%, 0.4%, 0.6%, 1%, 1.6%, 2.5%, 4%, and	Precision of the pressure gauge. The numeric input in the custom option is the accuracy of the pressure gauge. For example: For 1.5% accuracy

	custom	would be input as 1.5 through the numeric keyboard, which has a range of (0.001 ~ 100)%
Resolution	Minimum resolution: 0.001	The resolution of the pressure gauge
Owner	Letter, numeral, symbol	Owner of the pressure gauge
Location	Letter, numeral, symbol	Location position of the pressure gauge
Note	Letter, numeral, symbol	Notes of the pressure gauge

### 3. Task setting features

Select the task in the task list to enter the instrument parameter interface, click the start icon to enter the execution information interface, and input the calibration information of the pressure gauge.

Table 26 Task setting of dial pressure gauge

Subject	Valid value	Description
Set points	The Valid value of the set point pressure depends on the pressure range of the gauge; up to 17 calibration points can be set	Set the calibration points for the task, and the calibrator will automatically set the default calibration point based on the range of the calibrated instrument and the number of the calibration points. Any point can be manually selected to be changed to a different point. The set point needs to be within the range of the pressure gauge. Change the number of the calibration points through the arrow key on the right side of the screen or by clicking the number of the calibration points.
Cycle number	1, 2, 3	Select the number of cycles
Stroke	Round trip / one way	Select the calibration task stroke mode

Dwell time	Integer of (1 ~ 600) seconds	The waiting time to take the readings before the next set point.
Tapping	Enable, disable	When enabled the value of the dial pressure gauge needs to be input twice for each calibration point, and then the calibrator will shift to the next calibration point to continue the task.

#### 4. Task start

Click  to start the task process:

(1) If connecting an external pressure module, it needs to select an input reference.

(2) Click  on the right to zero the pressure module.

(3) Click the task start button at the bottom right and select the execution mode as automatic execution or manual execution.

◆ Automatic execution: The default measurement value is same as the set point value. The measured value can be manually changed.

◆ Manual execution: Every time a set point is reached, the value will need to be entered before going to the next set point.

(4) Click the right icon of the display will switch the calibration interfaces.

(5) Standard process of calibration

◆ When the calibration point is reached and stable (The number on the upper left pressure output window turns green and there is a sound), enter the measurement value for the dial pressure gauge.

◆ Click the Enter key on the keyboard or  in the lower right corner of the screen to go to the next calibration point.

At this time, the calibrator will start to control the pressure. The automatic mode can be performed without manually

advancing if the measurement value is the same as the set point value. Note: When enabling the tapping function, pay attention to the status of before/after tapping as prompted by the function screen, and input the indicated value of the gauge before/after tapping.

- ◆ Repeat above steps for the remaining calibration points until the entire pressure calibration process is completed;
- (6) After the entire calibration process is completed, it will automatically enter the report interface.

#### 5. Task end

The ADT762 provides calibration task data review, sorting and save functions.



- ◆ After the task is over, the user can choose to see the result of the task through the data view icon or the task data.
- ◆ The user can also click  to abandon the task data and execute the task again.
- ◆ Task data can be stored by clicking  in the save interface and the following information can be entered:

Table 27 Task Save

Subject	Valid value	Description
Operator	Letter, numeral, symbol	Calibration task operator information
Execution time	2000/01/01-2099/12/31	Calibrator task execution date
Ambient temperature	Numeral	Ambient temperature during task
Temperature unit	K, °C, °F	Unit of ambient temperature during task
Ambient humidity	Numeral	Ambient humidity during task
Save as	As found, as left and both	Save pre-adjustment data or post-adjustment data, or both

- ◆ After saving, return to the task interface.

### 5.2.2 Digital pressure gauge

#### 1. Connection

Connect the calibrator and digital pressure gauge as shown in Figure 21;

#### 2. New task

Select the “digital pressure gauge” icon  in the test type list. The other contents are the same as those in Para. 5.2.1 New Task for Calibration of the dial pressure gauge. The accuracy setting for calibration of the digital pressure gauge is slightly different from the dial pressure gauge. The Valid values of the accuracy for calibration of the digital pressure gauge are 0.025%, 0.05%, 0.1%, 0.16%, 0.25%, 0.4%, 1 %, 1.6%, 2.5%, 4%, and custom.

3. For the contents of task setting, refer to Para. 5.2.1 Task setting for calibration of the dial pressure gauge. There are no settings for tapping and input format for calibration of the digital pressure gauge.

4. For the contents of task start, refer to Para. 5.2.1 task start for calibration of the dial pressure gauge.

5. For the contents of task end, refer to Para. 5.2.1 task end for calibration of the dial pressure gauge.

### 5.2.3 Pressure transmitter

During the task, the calibrator can automatically measure and record the current or voltage value output from the transmitter.

#### 1. Connection

Refer to Para. 3.6.2 for connection.

#### 2. New task

Select the “pressure transmitter” icon  in the test type list, and input the information of the calibrated pressure transmitter in turn:

Table 28 Task mode pressure transmitter information

Subject	Valid value	Description
Name	Letter, numeral, symbol	Name of the pressure transmitter
Serial number	Letter, numeral, symbol	Serial number of the pressure transmitter
Model	Letter, numeral, symbol	Model of the pressure transmitter
Pressure type	Gauge pressure, absolute pressure, differential pressure	Pressure type of the pressure transmitter
Input	Depends on the pressure transmitter	Pressure range of the pressure transmitter
Output	Analog signal: (4~20)mA, (0~10)mA, (0~20)mA, (1~5)V, (0~5)V, (0~10)V, and custom	Electric signal output range of current/voltage and pressure transmitters
	HART device: Process variable (PV), percentage, process variable analog output (PVAO), and loop current	Electrical signal output type of HART device
	PROFIBUS PA	PROFIBUS output
Accuracy	0.05%, 0.1%, 0.2%, 0.5%, 1%, 1.5%, 2%, 2.5%, and custom	Accuracy of the pressure transmitter

Transfer function	Linear/ square root/ square	Transfer function to be selected
Owner	Letter, numeral, symbol	Owner of the pressure transmitter
Location	Letter, numeral, symbol	Location of the pressure transmitter
Notes	Letter, numeral, symbol	Notes of the pressure transmitter

### 3. Task setting

For the contents, refer to Para. 5.2.1 Task settings for calibration of the dial pressure gauge.

### 4. Task start

◆ For the contents, refer to Para. 5.2.1 Task start for calibration of the dial pressure gauge.

◆ The transmitter output is an analog signal and may need loop power supplied either internally or externally.

◆ For HART devices click  on the right to configure HART.

◆ For PROFIBUS PA click  on the right to configure PA.

◆ In the calibration interface, click the task start button at the bottom right. In the pressure transmitter task mode, the user can choose the automatic execution mode or the manual execution mode.

◆ After the entire calibration process is completed, it will automatically enter the report interface.

### 5. Task end

For the contents, refer to Para. 5.2.1 Task end for calibration of the dial pressure gauge.

## 5.2.4 Pressure Transducer

### 1. Connection

- ◆ Connect the calibrator and the pressure transducer (providing excitation current or excitation voltage) as shown in Figure 29.

### 2. New task

Select the “pressure transducer” icon  in the test type list and input the information of the pressure transducer.

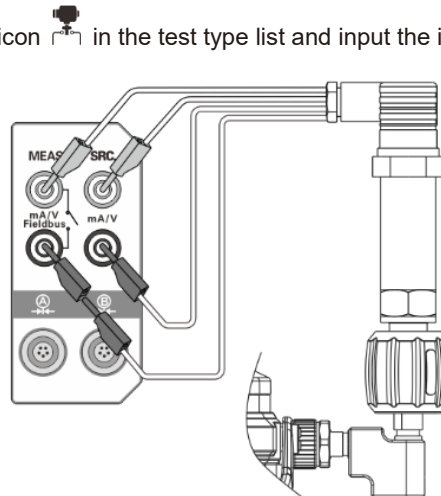

Figure 31 Calibration of the pressure transducer

Table 29 Task mode pressure transducer information

Subject	Valid value	Description
Name	Letter, numeral, symbol	Name of the pressure transducer
Serial number	Letter, numeral, symbol	Serial number of the pressure transducer
Model	Letter, numeral, symbol	Model of the pressure transducer
Pressure type	Gauge pressure, absolute pressure, differential pressure	Pressure type of the pressure transducer
Input	Depends on the pressure sensor	Pressure range of the pressure transducer
Output	(4~20)mA, (0~20)mA, (1~5)V, (0~10)V, (0~100)mV, (0~200)mV, and custom	Electric signal output range of current/voltage and pressure transducer
Accuracy	0.01%, 0.02%, 0.05%, 0.1%, 0.2%, 0.5%, 1%, 1.5%, 2.5%, 4%, and custom	Precision of the pressure transducer
Transfer function	Linear, square root, square	Type of transfer function of the pressure transducer
Owner	Letter, numeral, symbol	Owner of the pressure transducer
Location	Letter, numeral, symbol	Location of the pressure transducer
Notes	Letter, numeral, symbol	Notes of the pressure transducer

### 3. Task setting

For the contents, refer to Para. 5.2.1 Task setting for calibration of the dial pressure gauge.

### 4. Task start

- ◆ For some contents, refer to Para. 5.2.1 Task start for calibration of the dial pressure gauge. Note that it does not require a manual input of the indicated value in this test.
- ◆ If connecting an external pressure module, it needs to be selected
- ◆ If loop power is required, please set it before starting

5. For the contents of task end, refer to Para. 5.2.1 task end for calibration of the dial pressure gauge.

## 5.2.5 Pressure switch

### 1. Connection

- ◆ Connect the calibrator and the pressure switch as shown in Figure 25;

### 2. New task

Select the “pressure switch” icon  in the test type list and input the information of the pressure switch.

Table 30 Task mode pressure switch information

Subject	Valid value	Description
Name	Letter, numeral, symbol	Name of the pressure switch
Serial number	Letter, numeral, symbol	Serial number of the pressure switch
Model	Letter, numeral, symbol	Model of the pressure switch

Pressure type	Gauge pressure, absolute pressure, differential pressure	Pressure type of the pressure switch, check the support conditions according to the calibrator model
Input	Depends on the pressure switch	Pressure range of the pressure switch
Accuracy	0.5%, 1%, 1.5%, 2%, 2.5%, 4%, and custom	Precision of the pressure switch. The numeral input in the custom option is the precision level of the pressure switch
Set point	Depends on the range of the pressure switch	Operating point of the pressure switch
Action type	Normally closed, normally open	Action type of the pressure switch
Switch type	Mechanical switch, NPN switch, PNP switch	Type of the pressure switch
Dead band	Depends on the range of the pressure switch	Dead band range of the pressure switch
Owner	Letter, numeral, symbol	Owner of the pressure switch
Location	Letter, numeral, symbol	Location of the pressure switch
Notes	Letter, numeral, symbol	Notes of the pressure switch

### 3. Task setting



Select the task in the task list to enter the instrument parameter interface, click the start icon to enter the execution information interface.

- ◆ Input the number of cycles, 1, 2 or 3.

### 4. Task start

---

Click  on the right side of the screen to zero the calibrator.

- ◆ Click the execution button to start the task.
- ◆ The upper left of the screen indicates the reading value of the current control pressure, and the upper right indicates the switch status.
- ◆ During the test, it can click the graph display button  and the table display button  to switch to graph display or table display.
- ◆ The switch action status and action value will be recorded and displayed in the table interface
- ◆ When the internal pressure module is selected as the standard, the pressure switch test method is based on slow rate in the control settings and the rate is gradually attenuated following the change of state for the switch.
- ◆ When using an external pressure module, the control must be done manually.
- ◆ Click the stop icon at the bottom right of the screen to end the task.

5. Task end

For the contents, refer to Para. 5.2.1 Task end for calibration of the dial pressure gauge.

## 5.2.6 I/P converter

1. Connection

- ◆ Connect the calibrator and the I/P converter as shown in Figure 26;
- ◆ Never apply pressure out of the range of the calibrator.
- ◆ If the loop power supply is enabled (with maximum load of 50mA), check the load capacity.

2. New task

Select the “I/P converter” icon  in the test type list and input the information of the I/P converter.

Table 31 Task mode I/P converter information

Subject	Valid value	Description
Name	Letter, numeral, symbol	Name of the I/P converter
Serial number	Letter, numeral, symbol	Serial number of the I/P converter
Model	Letter, numeral, symbol	Model of the I/P converter
Pressure type	Gauge pressure, absolute pressure, differential pressure	Pressure type of the I/P converter
Input	(4~20)mA, (4~12)mA, (12~20)mA, and custom	Input current range of the I/p converter
Output	Depends on the I/P converter	Output pressure range of the I/p converter
Accuracy	0.025%, 0.05%, 0.1%, 0.16%, 0.25%, 0.4%, 1%, 1.6%, 2.5%, 4%, and custom	Precision of the I/P converter.
Transfer function	Linear, square root	Type of transfer function of the I/P converter
Owner	Letter, numeral, symbol	Owner of the I/P converter
Location	Letter, numeral, symbol	Location of the I/P converter
Notes	Letter, numeral, symbol	Notes of the I/P converter

### 3. Task setting

For the contents, refer to Para. 5.2.1 Task setting for calibration of the dial pressure gauge.

### 4. Task start

- ◆ For some contents, refer to Para. 5.2.1 Task start for calibration of the dial pressure gauge.
- ◆ Enable or disable loop power as required.
- ◆ If the external pressure module is connected, the internal module or the external module will be the selected for the calibrated output standard;
- ◆ If the internal pressure range is selected, the pressure output range of the calibrated converter shall not exceed the internal range of the calibrator;
- ◆ If the external pressure module is selected, the pressure output range of the calibrated converter shall not exceed the range of selected external pressure module.

### 5. Task end

For the contents, refer to Para. 5.2.1 Task end for calibration of the dial pressure gauge.

## **5.2.7 Signal isolator**

### 1. Connection

- ◆ Connect the calibrator and the signal isolator as shown in Figure 30;

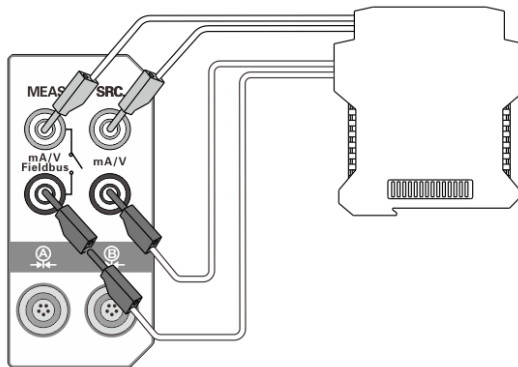

Figure 32 Calibration of the signal isolator

## 2. New task

Select the “Signal isolator” icon  in the test type list and input the information of the calibrated signal isolator.

Table 32 Task mode signal isolator information

Subject	Valid value	Description
Name	Letter, numeral, symbol	Name of the signal isolator
Serial number	Letter, numeral, symbol	Serial number of the signal isolator

Model	Letter, numeral, symbol	Model of the signal isolator
Accuracy	0.05%, 0.1%, 0.2%, 0.5%, 1%, 1.5%, 2%, 2.5%, and custom	Precision of the signal isolator.
Input	(0~25)mA, (0~16)V	Input current range or voltage range of the signal isolator
Output	(-50~50)mA, (-30~30)V, (-300~300)mV	Output current range or voltage range of the signal isolator
Transfer function	Linear, square root	Type of transfer function of the signal isolator
Owner	Letter, numeral, symbol	Owner of the signal isolator
Location	Letter, numeral, symbol	Location of the signal isolator
Notes	Letter, numeral, symbol	Notes of the signal isolator

### 3. Task setting

For the contents, refer to Para. 5.2.1 Task setting for calibration of the dial pressure gauge.

### 4. Task start

- ◆ For some contents, refer to Para. 5.2.1 Task start for calibration of the dial pressure gauge. Note that it does not require manual input of the indicated value in this test.
- ◆ Enable or disable loop power as required for the input.
- ◆ For Enable or disable loop power as required for the output.

### 5. Task end

For the contents, refer to Para. 5.2.1 Task end for calibration of the dial pressure gauge.

## 5.2.8 Electric Contacting pressure gauge

### 1. Connection

Connect the calibrator and the electric contacting pressure gauge as shown in Figure 31;

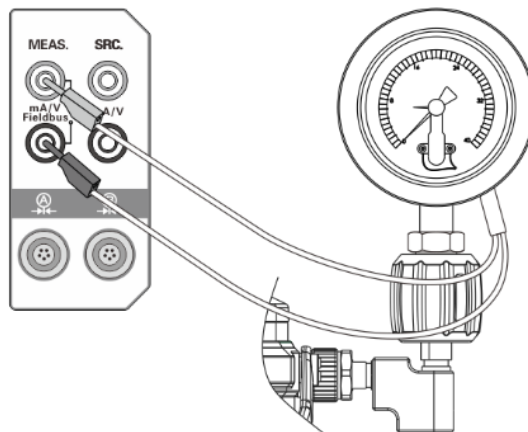



Figure 33 Calibration of the electric contacting pressure gauge

### 2. New task

Select the “Electric contacting pressure gauge” icon  in the test type list and input the information of the calibrated

contact pressure gauge.

Table 33 Task mode for contact pressure gauge information

Subject	Valid value	Description
Name	Letter, numeral, symbol	Name of the contact pressure gauge
Serial number	Letter, numeral, symbol	Serial number of the contact pressure gauge
Model	Letter, numeral, symbol	Model of the contact pressure gauge
Pressure type	Gauge pressure, absolute pressure, differential pressure	Pressure type of the pressure sensor
Range	Depends on the pressure gauge	Range and unit of the contact pressure gauge
Accuracy	0.06%, 0.1%, 0.16%, 0.25%, 0.4%, 0.6%, 1%, 1.6%, 2.5%, 4%, and custom	Precision of the contact pressure gauge.
Division Value	Minimum resolution: 0.001	Minimum resolution of the contact pressure gauge
Owner	Letter, numeral, symbol	Owner of the contact pressure gauge
Location	Letter, numeral, symbol	Location of the contact pressure gauge
Notes	Letter, numeral, symbol	Notes of the contact pressure gauge

### 3. Task setting

Select the task in the task list to enter the instrument parameter interface, click the start icon to enter the execution

information interface, and input the calibration process information of the contact pressure gauge in turn:

Table 34 Task setting of contact pressure gauge

Subject	Valid value	Description
Set point list	Valid value of the set point pressure depends on calibrated gauge. Pressure range; up to 17 calibration points can be set	Set the calibration point for the task, and the calibrator will automatically set the default calibration points based on the range of the calibrated instrument and the number of the calibration points. The value and number of points can be adjusted as necessary.
Cycle number	1, 2, 3	Select the number of calibration process cycles
Stroke	Round trip and one way	Select the calibration task stroke mode
Dwell time	Integer of (1 ~ 600) seconds	Waiting time from a stable set point the collection of all readings
Readout error test	On / off	Set whether enable the test for readout error
Tapping	Enable, disable	When enabled, the value of the pressure gauge needs to be in put twice for each calibration point, and then the calibrator will advance to the next calibration point to continue the task
Electric contact test	Open, close	Select whether to test the electric contacts
Electric contact test point list	Set valid contact value	Input valid value for electric contact and status

#### 4. Task start

- ◆ For some contents, refer to Para. 5.2.1 Task start for calibration of the dial pressure gauge.
- ◆ When starting the electric contact test in the task setting, it will test the on/off value, and during the test, it will switch to the data collection interface to collect the switch on and off values.

- ◆ Enable or disable loop power as required for the input.
- ◆ For Enable or disable loop power as required for the output.

#### 5. Task end

For the contents, refer to Para. 5.2.1 Task end for calibration of the dial pressure gauge.

### 5.2.9 Valve opening gauge

#### 1. Connection

- ◆ Connect the calibrator and the valve opening gauge as shown in Figure 32.

#### 2. New task

Select the “valve opening gauge” icon  in the test type list and input the information of the calibrated valve opening gauge.

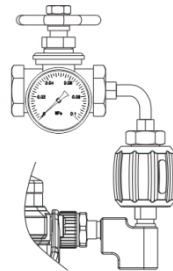

Figure 34 Calibration of the valve opening gauge

Table 35 Task mode valve opening gauge information

3. Task setting

Subject	Valid value	Description
Name	Letter, numeral, symbol	Name of the valve opening gauge
Serial number	Letter, numeral, symbol	Serial number of the valve opening gauge
Model	Letter, numeral, symbol	Model of the valve opening gauge
Pressure type	Gauge pressure, absolute pressure, differential pressure	Pressure type of the valve opening gauge
Input	Pressure: depending on the valve opening gauge	Pressure range of the valve opening gauge
	Electrical output: depending on the valve opening gauge	Current range of the valve opening gauge
Output	0%~100%, -360°~360°	Output range of the valve opening gauge
Accuracy	0.06%, 0.1%, 0.16%, 0.25%, 0.4%, 0.6%, 1%, 1.6%, 2.5%, 4%, and custom	Precision of the valve opening gauge.
Transfer function	Linear, square root, square	Type of transfer function of the valve opening gauge
Owner	Letter, numeral, symbol	Owner of the valve opening gauge
Location	Letter, numeral, symbol	Location of the valve opening gauge
Notes	Letter, numeral, symbol	Notes of the valve opening gauge.

---

For the contents, refer to Para. 5.2.1 Task setting for calibration of the dial pressure gauge.

4. Task start

- ◆ For some contents, refer to Para. 5.2.1 Task start for calibration of the dial pressure gauge.
- ◆ Set loop power settings as necessary.

5. Task end

For the contents, refer to Para. 5.2.1 Task end for calibration of the dial pressure gauge.

## 6. Application

### 6.1 Unit conversion

1. Click the menu in the upper right on the main interface to select the application, and then enter the pressure unit converter.
2. Supports conversion between multiple pressure units.

### 6.2 Pressure leak test

1. Pressure leak detection and pressurization method:
  - (1) Calibrator pressurization: select the internal high/low pressure range (or controllable pressure external module A/B), and the calibrator will automatically pressurize to the leak detection pressure point;
  - (2) External pressurization: Pressurized by an external pressure generator, and real-time pressure is measured by the pressure module.
2. Set up
  - (1) Select application in the function menu to enter the pressure leak test
  - (2) Click  to enter the setting
  - (3) Click the upper area of the interface to select the range: select the internal module range or external pressure module for leak testing
  - (4) Select unit: If the selected unit is not supported by the selected module, it will automatically restore to the last setting
  - (5) When there is a voltage-controlled external module A/B online, the internal voltage control option will appear,

---

indicating whether to use the external module to control the voltage

(6) set point

- ◆ When there is an external controllable voltage module online, the external voltage control module is selected, and the internal control voltage is turned on, the external control voltage set point can be set;
- ◆ Setpoints can be set directly when online internal modules are selected.
- ◆ Must not exceed the currently selected range;
- ◆ Use this setting as the leak detection pressure point;
- ◆ The target value when performing the test.

(7) Set dwell time

- ◆ Select the internal range: After the pressure control is stable during the execution (the real-time pressure value turns green display), switch to pressure measurement, and start the countdown waiting time.
- ◆ Select an external pressure module: the waiting time will be counted down after the execution starts.
- ◆ After the waiting time is over, enter the test time.

(8) Set test time



- ◆ Select the internal range: After entering the test time, start the countdown, implement the test, and stop the test when the timer reaches 0;
- ◆ Select an external pressure module: the same as the internal range.

(9) pressure type

- ◆ Gauge

3. Perform the test

(1) Internal range

- ◆ Take the pressure setting as the target value to control the pressure;
- ◆ After stabilization (the real-time pressure value turns green), stop the control and switch to the measurement mode, and count down the waiting time;
- ◆ Record the pressure at the end of the waiting time as the starting pressure;
- ◆ Start the test, count down the test time, and start to calculate the real-time leakage, real-time leakage = initial pressure – real-time pressure;
- ◆ Record the pressure at the end of the test time as the ending pressure, and then vent the calibrator to the atmosphere;
- ◆ The whole leak detection process is over, and the final leakage = initial pressure – ending pressure;
- ◆ Press the right side of the screen during 4)  To stop this test, press  and  You can switch freely between table and graph form.
- ◆ After the test is completed, click the save icon on the right side of the screen to save the test.

## (2) External pressure module

- ◆ Connect the pressure module;
- ◆ First apply pressure to the leak detection point;
- ◆ according to  key or the start icon on the right side of the screen to start execution, start the countdown waiting time, and record the real-time pressure at the end of the waiting time as the starting pressure;
- ◆ Start the test, count down the test time, and start to calculate the real-time leakage, real-time leakage = initial pressure – real-time pressure;
- ◆ Record the pressure at the end of the test time as the end pressure;
- ◆ The whole leak detection process is over, and the final leak volume = initial pressure – ending pressure;

(3) The whole process will be shown in stages in the leak detection curve diagram at the bottom of the screen;

#### 4. Check



(1) After entering the pressure leak test interface, the previously saved pressure leak test items are displayed, click to enter the view interface of the test

(2) Click  and  Can switch between table and graph form

#### 5. Delete

(1) After entering the pressure leak test interface, click  After that, all test result items in the current interface enter the state with selection,

(2) You can click to select the target item, or click the icon  Check all options

(3) Select the test result item to be deleted and click  After confirming, you can delete the selected item; click  Confirm to delete all items

### 6.3 Data log

#### 1. Set up and record

(1) Select Application in the function menu, then select the data logging function

(2) Click  to enter the setting

(3) In this interface, you can configure the record, click  You can enter the channel configuration interface and add the channel to be recorded. The options are as follows:





Table 36 Data logging module selection

Module type	Options
Pressure module	Pressure modules included with the current instrument
Electrical measurement	V, mV, mA range
Electrical output	V, mA, power level

- (4) Repeat ( 3 ) operation to add multiple channels
- (5) Click the channel item that has been set, you can set it to close and switch the color,
- (6) Set the recording interval, recording time, and recording points information

Table 37 Data logging information settings

Subject	Valid value	Description
Trigger method	cycle	Read-only parameter, cannot be changed
logging interval	0.5 to 100 seconds	interval between two recordings
Record time	0~ 9999 hours 59 minutes 59 seconds	Set the recording time. When the recording time is set, the number of recording points will be automatically updated.
Record points	2~1 000000	Set the number of recording points, when the number of recording points is set, the recording time will be automatically changed

- (7) Click  Enter the setting record name and operator interface, click  start recording
- (8) During recording, you can click  Switch to graph mode. Click to switch back; click  You can stop

recording halfway through

(9) It is automatically saved after the recording is completed.

## 2. Check

(1) When entering the main interface of the data logging application, the history items are displayed, click to view



(2) After clicking the item to be viewed, enter the information display of the item, click the bottom  to switch the icon mode and the control center, the control center records the configuration information of this record, including the selected channel settings and record information settings

(3) Click  You can view the data list to display the recording time and detailed values of each point in the data record

## 3. Export and delete

(1) Enter the main interface of the data logging application

(2) Export: After inserting the U disk, click , can export data to U disk

(3) delete: click  After that, all test result items in the current interface enter the state with selection, you can manually select the record item to be deleted, or click the icon  to select all, then click , you can delete the selected item.

## 7. HART Communicator



The calibrator provides full HART communicator function. Using the original HART DD file, the calibrator can be used to complete almost all HART pressure device maintenance and debugging, including parameter modification, fault diagnosis, daily maintenance and calibration, etc. Because the operation of communicator on the HART device depends on the DD file, the operation methods of different HART devices are quite different, so refer to the operation instructions of the HART device before using the communicator function.

Note: During communication with a HART device, the calibrator acts as a master station all the time. To avoid damaging the control system, you must separate the HART device from the control system before connecting the calibrator to HART device.

### 7.1 HART connection and search



See 3.3.3 HART Communication connection and search.

### 7.2 HART communicator operation

- ◆ Read the parameters in HART which may be modified. The root directory options are 1-4. Depending on the HART device, the parameters that have been modified but not written in HART are highlighted in yellow in the list. Click  to finish the operation of writing into the HART device.
- ◆ After entering, click  on the right side of the screen to view the explanation information of some parameters.
- ◆ After entering the parameter editing interface, click the control center  icon in the status bar to copy the indications of the internal pressure module, A and B indications of the external pressure modules, HART

---

indications, and the electrical measurement indications.

- ◆ Click  and  on the right side of the screen to view the communication status and the device status respectively. After entering, the open circle on the right side of the list indicates that there is no abnormality or it indicates that the item is abnormal
- ◆ Click **T<sub>ref</sub>** on the right side of the screen to return to the main interface of the device. To return to the HART communicator again, click  in the upper right corner of the screen.

## **8. System maintenance**

### **8.1 Device information view**

- ◆ On the system setting interface, select the product information. For details, see Para. 4.9 Product information.
- ◆ When the external pressure module is online, it can also view its related information.

### **8.2 Diagnostic information**

In case of any abnormalities of the calibrator, there will be a corresponding prompt message, and the message notification center icon on the top status bar will turn red and flash for alarm.

### **8.3 Check the sealing performance of the calibrator**

The sealing performance of the calibrator has a crucial impact on its control speed and control pressure stability. Slow pressurization speed, long stabilization time of the control output, and too much fluctuation of the output pressure in the process may all be caused by poor sealing. The method of checking the sealing performance of the calibrator is as follows:

- ◆ Use a plug (standard fitting) to block the outlet (OUTLET).
- ◆ Go to the diagnostic test under maintenance, refer to Para. 4.5.2, select the low/high pressure module pressure leakage and emptying test, and check the results after the self-test of the test is completed.

## 8.4 Maintenance

### 8.4.1 Liquid reservoir

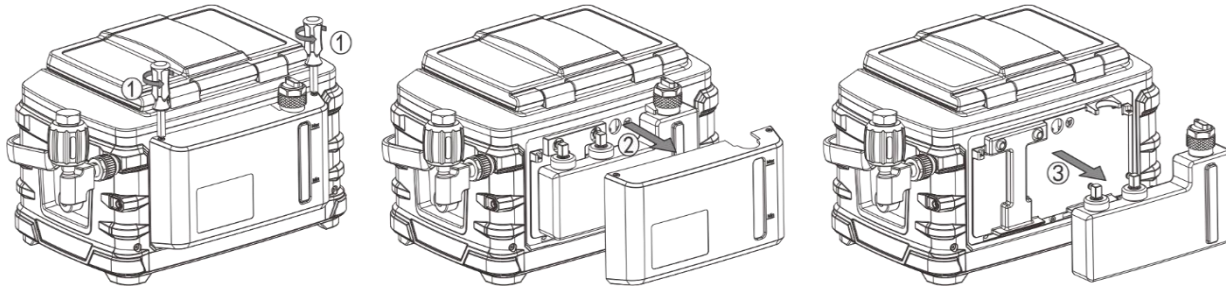

Figure 35 Disassembly of the liquid reservoir

1. The maintenance of the liquid reservoir is as shown in Figure 33:

(1) Use a Phillips screwdriver to rotate the bolt counterclockwise, and stop when the nut starts to rise , as shown in the figure ①;

(2) Remove the liquid reservoir cover back , as shown in the figure ②;

(3) Pull out the liquid connection of the reservoir and remove the liquid reservoir , as shown in the figure ③.

2. Maintenance and maintenance of the liquid storage tank, as shown in Figure 34.

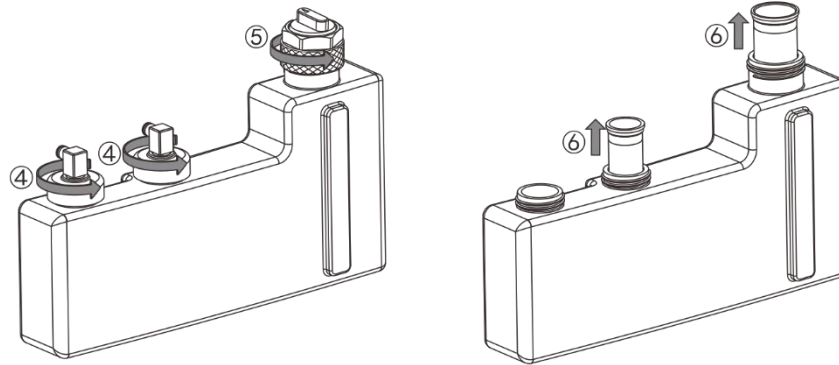

Figure 36 Reservoir Assembly Maintenance

- (1) Rotate the two hydraulic nuts counterclockwise respectively, remove them, check the sealing ring on the hydraulic interface, and replace it if it is damaged, as shown at position ④ ;
- (2) Rotate the vent valve nut counterclockwise to remove it, as shown at position ⑤ ;
- (3) Take out two liquid line filters and liquid injection filters, respectively, for cleaning or replacement, as shown in position ⑥ in the figure. The liquid line filters and liquid injection filters have different sizes and cannot be mixed;
- (4) Clean or replace the liquid storage tank and replace it with new media;

### 3. Reservoir Assembly Installation

Reverse the steps in 1 and 2 to assemble the reservoir assembly.

Note: When installing the hydraulic interface, the heights of the two hydraulic interfaces can be adjusted appropriately to suit the height of the corresponding joint of the whole machine.

### 8.4.2 Liquid reservoir filling

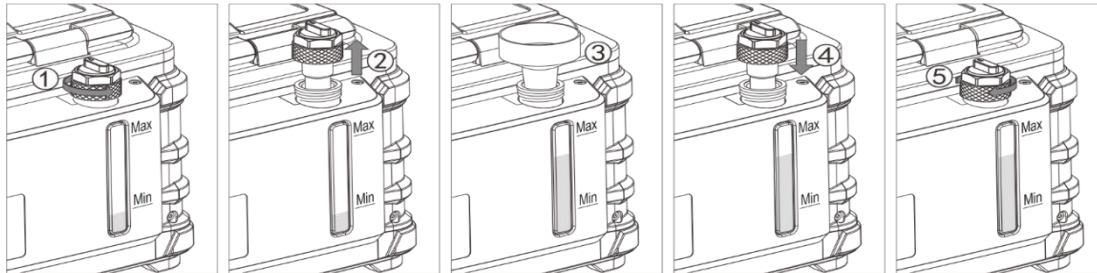

Figure 37 Liquid reservoir filling

1. Before starting the machine. When the liquid level is lower than the MIN mark, perform the liquid replenishment operation;
2. Rotate the vent valve counterclockwise , as shown in ① , remove it, and keep the filter , as shown in ② ;
3. Put the small metal funnel into the filter screen in the liquid injection port , as shown in the figure ③, and then carry out the liquid injection operation, and the liquid level should not exceed the MAX mark;
4. Put the vent valve back into the injection port, as shown in the figure ④ ;

5. Tighten the vent valve clockwise, as shown in ⑤.

Note: The liquid refilling operation can only be carried out before power on the unit or after the shutdown.

### 8.5 Replace the output filter and O-ring

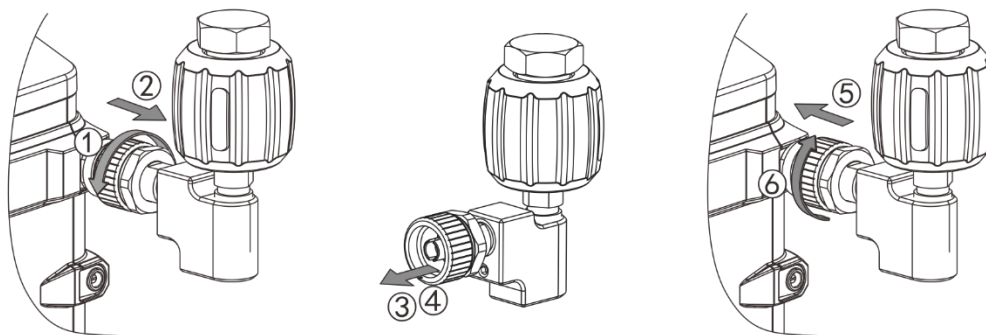

Figure 38 Maintenance of pressure outlet

The maintenance of the position of the pressure output port is shown in the figure above:

1. Rotate the hexagonal nut counterclockwise to completely unscrew it from the fixed joint , as shown in the figure ① ;
2. Remove the single connector assembly outward , as shown in ② ;

3. Remove the filter, replace or clean the filter, and then re-press it into the corresponding groove , as shown in the figure ③ ;
4. Check the condition of the sealing ring and replace it if it is damaged ;
5. Insert the single connector assembly into the fixed connector, pay attention to the direction of the single connector assembly , as shown in the figure ⑤ ;
6. Rotate the hexagonal nut clockwise until it is tightened , as shown in the figure ⑥ ;
7. Maintenance interval, 3 to 6 months/time or according to usage.

Note: Make sure to do this with the calibrator fully depressurized and powered off.

### **8.6 Special notice for water version**

1. Replace the water regularly (10 days is recommended), refer to Para. 8.4 for cleaning operation.
2. If the unit is not used for a long period, it is necessary to empty the water completely including the water in the reservoir.
3. Minimum working temperature: 5°C



**Additel Corporation**

2900 Saturn Street #B

Brea, CA 92821 USA

Phone: 714-998-6899

Email: [service@additel.com](mailto:service@additel.com)

website: [www.additel.com](http://www.additel.com)